

Errata

**Title & Document Type: HP 8711A RF Network Analyzer
Operating & Programming Manual
Manual Part Number: 08711-90107**

Revision Date: 1993-07-01

HP References in this Manual

This manual may contain references to HP or Hewlett-Packard. Please note that Hewlett-Packard's former test and measurement, semiconductor products and chemical analysis businesses are now part of Agilent Technologies. We have made no changes to this manual copy. The HP XXXX referred to in this document is now the Agilent XXXX. For example, model number HP8648A is now model number Agilent 8648A.

About this Manual

We've added this manual to the Agilent website in an effort to help you support your product. This manual provides the best information we could find. It may be incomplete or contain dated information, and the scan quality may not be ideal. If we find a better copy in the future, we will add it to the Agilent website.

Support for Your Product

Agilent no longer sells or supports this product. You will find any other available product information on the Agilent Test & Measurement website:

www.tm.agilent.com

Search for the model number of this product, and the resulting product page will guide you to any available information. Our service centers may be able to perform calibration if no repair parts are needed, but no other support from Agilent is available.

Operating and Programming Manual

HP 8711A RF Network Analyzer

SERIAL NUMBERS

This manual applies directly to any HP 8711A network analyzer with the serial prefix 3325A



HP Part No. 08711-90107
Printed in USA July 1993, Edition 1

Notice.

The information contained in this document is subject to change without notice.

Hewlett-Packard makes no warranty of any kind with regard to this material, including but not limited to, the implied warranties of merchantability and fitness for a particular purpose. Hewlett-Packard shall not be liable for errors contained herein or for incidental or consequential damages in connection with the furnishing, performance, or use of this material.

© Copyright Hewlett-Packard Company 1992, 1993
All Rights Reserved. Reproduction, adaptation, or translation without prior written permission is prohibited, except as allowed under the copyright laws.
1400 Fountaingrove Parkway, Santa Rosa CA, 95403-1799, USA

Warranty

This Hewlett-Packard instrument product is warranted against defects in material and workmanship for a period of one year from date of shipment. During the warranty period, Hewlett-Packard Company will, at its option, either repair or replace products which prove to be defective.

For warranty service or repair, this product must be returned to a service facility designated by Hewlett-Packard. Buyer shall prepay shipping charges to Hewlett-Packard and Hewlett-Packard shall pay shipping charges to return the product to Buyer. However, Buyer shall pay all shipping charges, duties, and taxes for products returned to Hewlett-Packard from another country.

Hewlett-Packard warrants that its software and firmware designated by Hewlett-Packard for use with an instrument will execute its programming instructions when properly installed on that instrument. Hewlett-Packard does not warrant that the operation of the instrument, or software, or firmware will be uninterrupted or error-free.

LIMITATION OF WARRANTY

The foregoing warranty shall not apply to defects resulting from improper or inadequate maintenance by Buyer, Buyer-supplied software or interfacing, unauthorized modification or misuse, operation outside of the environmental specifications for the product, or improper site preparation or maintenance.

NO OTHER WARRANTY IS EXPRESSED OR IMPLIED. HEWLETT-PACKARD SPECIFICALLY DISCLAIMS THE IMPLIED WARRANTIES OF MERCHANTABILITY AND FITNESS FOR A PARTICULAR PURPOSE.

EXCLUSIVE REMEDIES

THE REMEDIES PROVIDED HEREIN ARE BUYER'S SOLE AND EXCLUSIVE REMEDIES. HEWLETT-PACKARD SHALL NOT BE LIABLE FOR ANY DIRECT, INDIRECT, SPECIAL, INCIDENTAL, OR CONSEQUENTIAL DAMAGES, WHETHER BASED ON CONTRACT, TORT, OR ANY OTHER LEGAL THEORY.

Certification

Hewlett-Packard Company certifies that this product met its published specifications at the time of shipment from the factory. Hewlett-Packard further certifies that its calibration measurements are traceable to the United States National Institute of Standards and Technology, to the extent allowed by the Institute's calibration facility, and to the calibration facilities of other International Standards Organization members.

Regulatory Information

The regulatory information is in this front section.

Assistance

Product maintenance agreements and other customer assistance agreements are available for Hewlett-Packard products. For any assistance, contact your nearest Hewlett-Packard Sales and Service Office.

Safety Notes

The following safety notes are used throughout this manual. Familiarize yourself with each of the notes and its meaning before operating this instrument.

Caution



Caution denotes a hazard. It calls attention to a procedure that, if not correctly performed or adhered to, would result in damage to or destruction of the instrument. Do not proceed beyond a caution sign until the indicated conditions are fully understood and met.

Warning



Warning denotes a hazard. It calls attention to a procedure which, if not correctly performed or adhered to, could result in injury or loss of life. Do not proceed beyond a warning note until the indicated conditions are fully understood and met.

Instruction The **instruction documentation** symbol. The product is marked **Manual** with this symbol when it is necessary for the user to refer to the instruction in the manual.



General Safety Considerations

Caution



Before switching on this instrument, make sure that the line voltage selector switch is set to the voltage of the power supply and the correct fuse is installed.

Warning



This is a Safety Class I product (provided with a protective earthing ground incorporated in the power cord). The mains plug shall only be inserted in a socket outlet provided with a protective earth contact. Any interruption of the protective conductor, inside or outside the instrument, is likely to make the instrument dangerous. Intentional interruption is prohibited.

Warning



No operator serviceable parts inside. Refer servicing to qualified personnel. To prevent electrical shock do not remove covers.

Warning



If this instrument is used in a manner not specified by Hewlett-Packard Co., the protection provided by the instrument may be impaired.

Warning



For continued protection against fire hazard, replace line fuse only with same type and rating (5A/250V). The use of other fuses or materials is prohibited.

HP 8711A Documentation Map

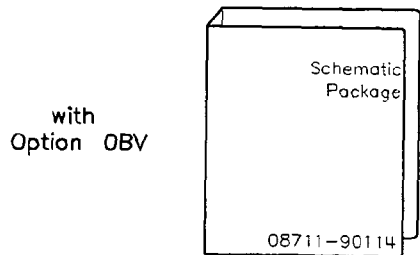
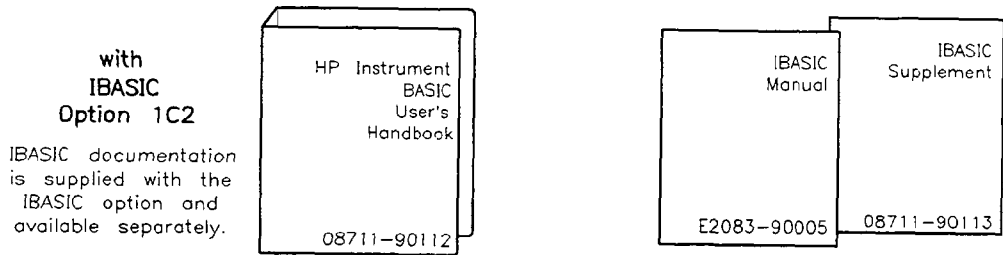
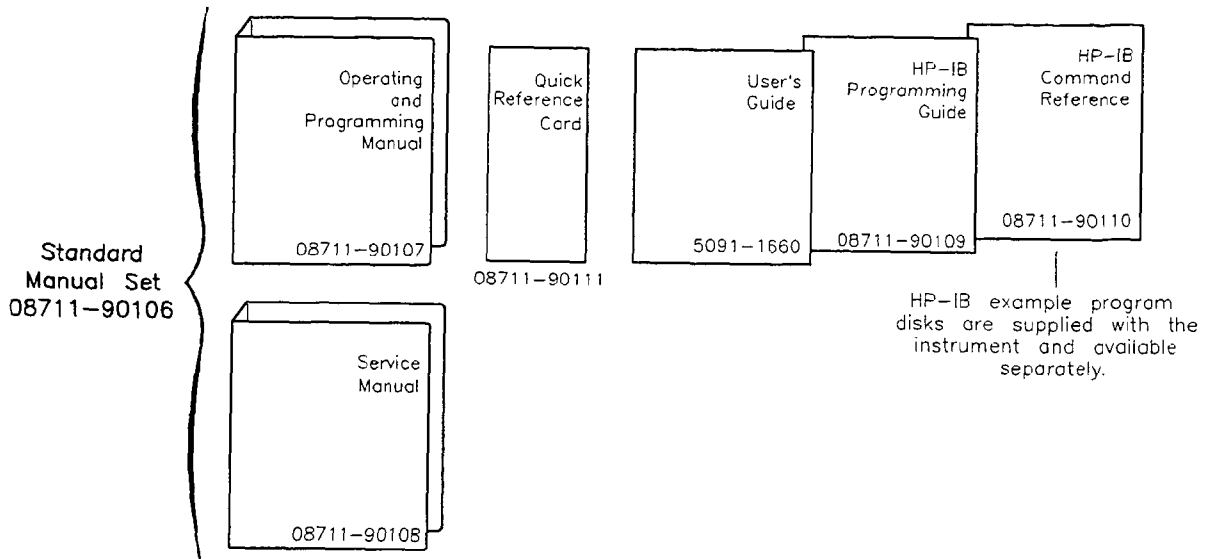

**Regulatory
Information**

The information on this page and the following page apply to the HP 8711A RF network analyzer product.

**Notice for Germany:
Noise Declaration**

LpA < 70 dB
am Arbeitsplatz (operator position)
normaler Betrieb (normal position)
nach DIN 45635 T. 19 (per ISO 7779)

ISM 1-A Industrial Scientific and Medical Group 1 Class A

DECLARATION OF CONFORMITY
according to ISO/IEC Guide 22 and EN 45014

Manufacturer's Name: Hewlett-Packard Co.
Manufacturer's Address: 1400 Fountaingrove Parkway
Santa Rosa, California 95403
U.S.A.

Declares that the product:

Product Name: RF Network Analyzer
Model Numbers: HP 8711A
Product Options: This declaration covers all options
of the above products.

Conforms to the following product specifications:

Safety: IEC 348:1978/HD 401:1980
CAN/CSA-22.2 No. 231 Series M89
EMC: CISPR 11:1990 /EN 55011:1991, Group 1 Class A
IEC 801-2:1991 /EN 50082-1:1992, 4 kV CD, 8 kV AD
IEC 801-3:1984 /EN 50082-1:1992, 3V/m, 26-500 MHz
IEC 801-4:1988 /EN 50082-1:1992, 500 V signal, 1000 V AC

Supplementary Information:

The product herewith complies with the requirements of the Low Voltage Directive 73/23/EEC
and the EMC Directive 89/336/EEC.

Santa Rosa, California

Location

7/14/93

Date

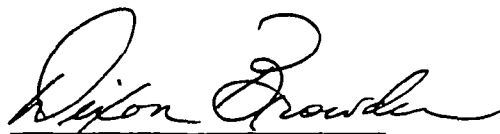

Dixon Browder / Quality Manager

European Contact:

Your local Hewlett-Packard Sales and Service Office or Hewlett-Packard GmbH, Department
ZQ/Standards Europe, Herrenberger Straße 130, D-7030 Böblingen (FAX: +49-7031-143143)

Contents

| | |
|--|------|
| 1. Brief Description of the HP 8711 | |
| HP 8711A Network Analyzer Description | 1-2 |
| Additional Features | 1-2 |
| Front Panel Features | 1-3 |
| Rear Panel Features | 1-5 |
| Features Available as Options | 1-6 |
| Previous Firmware Revisions | 1-7 |
| Organization of This Manual | 1-7 |
| Typographical Conventions | 1-8 |
| Instruments Covered by This Manual | 1-8 |
| Manual Set Description | 1-8 |
| HP 8711A System Specifications | 1-9 |
| Source Characteristics | 1-9 |
| Receiver Characteristics | 1-10 |
| Test Set Characteristics | 1-10 |
| Dynamic Accuracy (Narrowband) | 1-10 |
| HP 8711A Supplemental Operating Characteristics | 1-11 |
| Source Supplemental Characteristics | 1-11 |
| Receiver Supplemental Characteristics | 1-12 |
| Test Set Characteristics* | 1-12 |
| System Accuracy | 1-13 |
| Display Characteristics | 1-14 |
| General Characteristics | 1-15 |
| Front Panel Connectors | 1-15 |
| Rear Panel Connectors | 1-15 |
| 2. Installing the HP 8711 | |
| Check the Items Supplied with the Instrument | 2-1 |
| Select an Appropriate Installation Site | 2-1 |
| Set Up the Instrument | 2-2 |
| Connect Control Cables | 2-2 |
| Select AC Line Voltage Setting | 2-3 |
| Plug In AC Line Power Cables and Turn On Instruments | 2-4 |
| Set HP-IB Addresses | 2-4 |
| Configure Peripheral Settings | 2-5 |
| See Service Manual for Recommended Test Equipment Operation | 2-5 |
| Measurement Accessories Available | 2-6 |
| Calibration Kits | 2-6 |
| Adapter Kits | 2-6 |
| Test Port Cables | 2-6 |

| | |
|---|------|
| HP-IB Cables | 2-6 |
| External Detection Devices | 2-7 |
| 4. Making Measurements | |
| Configuring Measurements from the BEGIN Key | 4-1 |
| To Configure Measurements | 4-1 |
| Measuring Devices with an HP 8711A Network Analyzer | 4-3 |
| To Make a Transmission Measurement | 4-5 |
| Setting Up the Measurement | 4-6 |
| Displaying the Measurement Result | 4-7 |
| Increasing Dynamic Range by Increasing Receiver Input | 4-8 |
| Increasing Dynamic Range by Narrowing System Bandwidth | 4-9 |
| Increasing Dynamic Accuracy by Adding Measurement Averaging | 4-10 |
| To Make a Reflection Measurement | 4-10 |
| Setting Up the Measurement | 4-12 |
| Displaying the Measurement | 4-12 |
| Improving Accuracy by Making a Normalization Calibration | 4-13 |
| Improving Accuracy by Making a 1-Port Calibration | 4-14 |
| To Make a Power Measurement | 4-16 |
| Setting Up the Measurement | 4-16 |
| Displaying the Measurement | 4-17 |
| Improving Power Accuracy by Increasing Receiver Input | 4-18 |
| To Make a Conversion Loss Measurement | 4-19 |
| Setting Up the Measurement | 4-19 |
| Increasing Dynamic Range by Increasing Receiver Input | 4-21 |
| Increasing Dynamic Range by Narrowing System Bandwidth | 4-22 |
| Increasing Dynamic Accuracy by Adding Measurement Averaging | 4-23 |
| 5. Examining Measurement Results | |
| Activating Marker Functions | 5-2 |
| To Search for Specific Values on the Measurement Trace | 5-2 |
| Viewing the Entire Measurement Trace Display | 5-2 |
| Searching for Maximum and Minimum Values | 5-2 |
| Searching for Target Values | 5-3 |
| Searching for Bandwidth Values | 5-3 |
| To Measure Values in Reference to Other Values | 5-5 |
| Saving and Recalling Measurement Results | 5-5 |
| To Save a File | 5-6 |
| Selecting the Disk | 5-6 |
| Defining What You Save | 5-6 |

| | |
|---|------|
| Renaming a File | 5-7 |
| To Recall from a Disk or Internal Memory | 5-7 |
| To Make and Change Directories | 5-8 |
| Making Directories for DOS Disks | 5-8 |
| Changing Directories | 5-9 |
| To Format a Floppy Disk | 5-9 |
| Formatting a Disk in the Internal Drive with MS-DOS Format | 5-9 |
| Formatting a Disk in an External Drive with MS-DOS Format | 5-9 |
| Initializing a Disk in the Internal Drive with LIF Format | 5-10 |
| Printing and Plotting Measurement Results | 5-11 |
| To Connect the Printer or Plotter to the HP 8711A Network Analyzer | 5-11 |
| To Configure the HP 8711A Network Analyzer Hardcopy Port | 5-11 |
| Configuring the HP 8711A Network Analyzer for HP-IB Devices | 5-12 |
| Configuring the HP 8711A Network Analyzer for RS-232 Devices | 5-13 |
| To Define the Hardcopy Device Settings | 5-13 |
| Defining a Printing Device | 5-13 |
| Defining a Plotting Device | 5-14 |
| Restoring the Hardcopy Device Defaults | 5-14 |
| To Define the Hardcopy Output | 5-15 |
| To Title Displayed Measurement Results | 5-17 |
| To Generate a Hardcopy Output | 5-17 |
| To Save a Plot File to Disk | 5-18 |
| Limit Testing | 5-18 |
| To Create a Limit Test | 5-19 |
| Setting Up the Measurement | 5-19 |
| Setting up the Limit Test | 5-19 |
| Defining the Maximum Limit Lines | 5-20 |
| Defining Minimum Limit Lines | 5-21 |
| To Determine if a Measurement Is Out-of-Limits | 5-22 |
| To Edit Limits | 5-22 |
| Displaying Measurement Traces | 5-23 |
| To Display Measurements at Different Power Levels | 5-23 |
| To Display Different Characteristic Measurements | 5-24 |
| Viewing the Ratio of Two Measurement Traces | 5-26 |

| | |
|---|------|
| 6. Optimizing Measurements | |
| Increasing Sweep Speed | 6-2 |
| To Increase the Start Frequency | 6-2 |
| To Set the Sweep Time to AUTO Mode | 6-2 |
| To Widen the System Bandwidth | 6-2 |
| To Reduce the Amount of Averaging | 6-2 |
| To Reduce the Number of Measurement Points | 6-3 |
| To View a Single Measurement Channel | 6-3 |
| To Turn Off Alternate Sweep | 6-3 |
| To Turn Off Spur Avoidance | 6-3 |
| Increasing Dynamic Range | 6-4 |
| To Increase the Receiver Input Power | 6-4 |
| To Reduce the Receiver Noise Floor | 6-4 |
| Changing System Bandwidth | 6-4 |
| Changing Measurement Averaging | 6-5 |
| Reducing Trace Noise | 6-5 |
| To Activate Averaging for Reducing Trace Noise | 6-5 |
| To Change System Bandwidth for Reducing Trace Noise | 6-5 |
| To Eliminate Receiver Spurious Responses | 6-6 |
| Dithering to Shift Spurs | 6-6 |
| Activating Spur Avoidance | 6-6 |
| Increasing Measurement Accuracy (Measurement Cals) | 6-7 |
| To Determine if a Measurement Calibration Is Necessary | 6-7 |
| Conditions Where a Calibration Is NOT Necessary | 6-8 |
| Conditions Where a Calibration IS Necessary | 6-8 |
| Measurement Calibration Methods Available | 6-8 |
| Transmission and Reflection Calibrations Available | 6-9 |
| To Calibrate for a Transmission Measurement | 6-10 |
| To Calibrate for a Reflection Measurement | 6-11 |
| To Calibrate for a Power or Conversion Loss Measurement | 6-12 |
| To Calibrate with a User-Defined Cal Kit | 6-13 |
| How to Download Standards | 6-13 |
| Cal Kit File Notes | 6-13 |
| How To Edit Cal Kit Files | 6-14 |
| To Save the Measurement Calibration | 6-14 |
| Renaming the Calibration File | 6-15 |
| 7. Reference and Menu Map | |
| Format of Entries | 7-1 |
| Reference | 7-1 |
| Numerical and Symbolic Entries | 7-1 |
| Alphabetical Entries | 7-2 |

| | |
|--|------|
| A. Preset State | |
| Preset State | A-1 |
| Peripheral State | A-2 |
| B. Keyboard Front Panel Key Equivalents | |
| C. Internal Non-Volatile Memory Usage | |
| Three Types of Savable Information | C-1 |
| How to Determine the Amount of Memory Used | C-2 |
| What To Do If You Run Out of Memory | C-3 |
| How to Move or Delete a File from Memory | C-3 |
| Examples of Saves | C-4 |
| Example of Instrument State Save | C-4 |
| Example of Cal Save | C-4 |
| Example of Data Save | C-5 |
| Memory Usage Notes | C-5 |
| 8. How the Analyzer Works | |
| Network Analysis | 8-1 |
| What a Network Analyzer (NA) Measures | 8-2 |
| What a NA Is | 8-2 |
| The RF Source | 8-2 |
| Signal Separation | 8-3 |
| Post Separation Processes | 8-3 |
| Scalar vs Vector NAs | 8-3 |
| Related Topics | 8-3 |
| Types of Instrument Operation | 8-4 |
| Manual Operation | 8-4 |
| Automatic Operation | 8-4 |
| HP-IB Notes | 8-5 |
| Related Topics | 8-5 |
| Noise Reduction | 8-6 |
| How to Decrease the Noise Level | 8-6 |
| System Bandwidth Reduction | 8-7 |
| Averaging | 8-7 |
| Related Topics | 8-7 |
| Measurement Calibration | 8-8 |
| Cal Improves Measurements | 8-8 |
| The Significance of Systematic Errors | 8-8 |
| Types of Systematic Errors | 8-8 |
| Types of HP 8711 Cals | 8-9 |
| Transmission and Reflection Cal Options | 8-9 |
| How a Transmission or Reflection Cal Works | 8-10 |
| An Example of a Cal | 8-10 |
| How to Perform a Quality Cal | 8-11 |
| Related Topics | 8-11 |

Accessories

Index

Figures

| | |
|--|------|
| 1-1. HP 8711A RF Network Analyzer | 1-1 |
| 1-2. Front Panel Features | 1-3 |
| 1-3. Rear Panel Features | 1-5 |
| 2-1. Serial Number Plate on Rear Panel | 2-2 |
| 2-2. HP 8711A Network Analyzer Rear Panel Line Module and Selected Connectors | 2-3 |
| 4-1. Device under Test Response to an RF Signal | 4-3 |
| 4-2. Receiver Inputs for Transmitted, Reflected, and Reference Signals | 4-3 |
| 4-3. Broadband and Narrowband Detection Mode Inputs | 4-4 |
| 4-4. Equipment Setup for a Transmission Measurement | 4-6 |
| 4-5. Example of a Transmission Measurement | 4-7 |
| 4-6. Effects of Changing Receiver Input Power on Dynamic Range | 4-8 |
| 4-7. Effects of a System Bandwidth on Dynamic Range | 4-9 |
| 4-8. Effects of Adding Averaging on Dynamic Range | 4-10 |
| 4-9. Equipment Setup for a Reflection Measurement | 4-12 |
| 4-10. Example of a Reflection Measurement | 4-12 |
| 4-11. Connections for a Reflection Measurement Normalization | 4-13 |
| 4-12. Example of a Reflection Measurement with a Normalization Calibration | 4-13 |
| 4-13. Connections for Making a 1-Port Measurement Calibration | 4-14 |
| 4-14. Example of a Reflection Measurement with a 1-Port Calibration | 4-15 |
| 4-15. HP 8711A Network Analyzer Absolute Power Accuracy (10 to 1300 MHz) | 4-16 |
| 4-16. Equipment Setup for a Power Measurement | 4-16 |
| 4-17. Example of a Power Measurement | 4-17 |
| 4-18. Example of a Power Measurement with Increased Power Accuracy | 4-18 |
| 4-19. Equipment Setup for a Mixer Conversion Loss Measurement | 4-19 |
| 4-20. Example of a Conversion Loss Measurement | 4-20 |
| 4-21. Effects of a Receiver Input Power on Dynamic Range | 4-21 |
| 4-22. Effects of a System Bandwidth on Dynamic Range | 4-22 |
| 4-23. Effects of Adding Averaging on Dynamic Range | 4-23 |
| 5-1. Markers Searching for Minimum and Maximum Values with Tracking On | 5-3 |
| 5-2. Markers Searching for Bandwidth Values | 5-4 |
| 5-3. Hardcopy Components and Formats Available | 5-16 |

| | |
|--|------|
| 5-4. Graph Components Available | 5-17 |
| 5-5. Example of a Limit Test | 5-19 |
| 5-6. Displaying Two Measurements Made at Different Power Levels | 5-24 |
| 5-7. Example of Full and Split Screen Displays | 5-25 |
| 5-8. Gain Difference between Two Measured Power Levels | 5-26 |
| 6-1. Connections for a Transmission Measurement Calibration | 6-10 |
| 6-2. Connections for a Reflection Measurement Calibration | 6-11 |
| 6-3. Connections for a Power or Conversion Loss Measurement Calibration | 6-12 |
| 7-1. Average Menu | 7-5 |
| 7-2. Begin Menu | 7-7 |
| 7-3. Calibration Menu | 7-9 |
| 7-4. Display Menu | 7-15 |
| 7-5. Format Menu | 7-19 |
| 7-6. Frequency Menu | 7-20 |
| 7-7. Hardcopy Menu | 7-22 |
| 7-8. Marker Menu | 7-28 |
| 7-9. Measurement Menu | 7-30 |
| 7-10. Simplified Internal Instrument Measurement Paths | 7-31 |
| 7-11. Parallel Port Pinouts | 7-35 |
| 7-12. Power Menu | 7-36 |
| 7-13. Save Recall Screen Annotations | 7-41 |
| 7-14. Save Recall Menu | 7-42 |
| 7-15. Scale Menu | 7-44 |
| 7-16. Screen Annotations | 7-44 |
| 7-17. Source Menu | 7-47 |
| 7-18. Sweep Menu | 7-50 |
| 7-19. System Options Menu | 7-52 |
| C-1. Save Recall Screen Annotations | C-3 |
| 8-1. High Frequency Device Characterization | 8-2 |
| 8-2. Block Diagram of Network Analyzer | 8-2 |
| 8-3. Major Components of Remote Automatic Operation | 8-5 |
| 8-4. The Effect of Noise Reduction (lower) on Trace Noise | 8-6 |
| 8-5. Sources of Errors | 8-8 |
| 8-6. Mismatch Errors | 8-9 |

Brief Description of the HP 8711

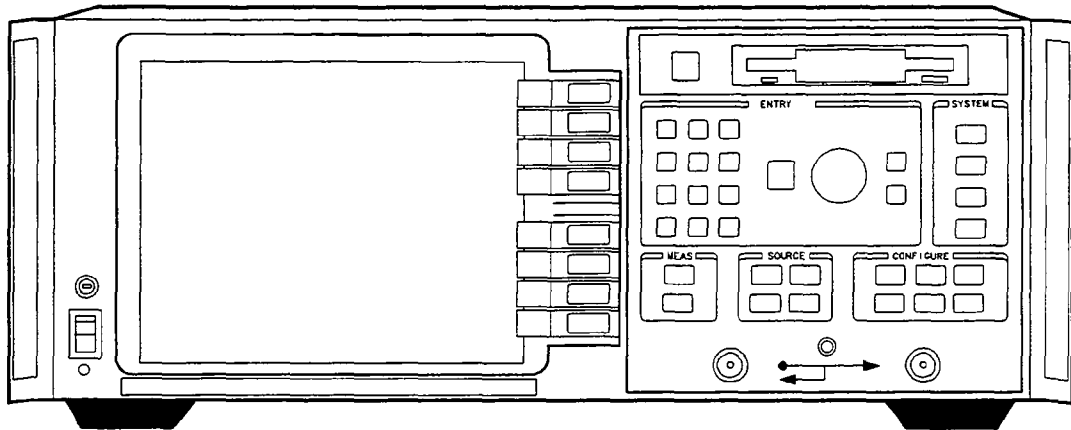

ad69a

Figure 1-1. HP 8711A RF Network Analyzer

This chapter describes:

- the HP 8711A RF network analyzer and its options
- this manual
- the HP 8711A RF network analyzer's specifications

For an overview of the manual set, see the documentation map at the front of this manual.

HP 8711A Network Analyzer Description

The HP 8711A is an easy-to-use RF network analyzer optimized for production measurements of reflection and transmission parameters. It integrates an RF synthesized source, test set, receiver, and display in one compact box.

The source features 1 Hz resolution, 50 ms (or faster) sweep time, and up to +16 dBm output power.

The built-in transmission/reflection test set features 40 dB directivity (corrected).

The three-channel, dual mode receiver provides a dynamic range of 90 dB in narrowband measurement mode. For measurements of frequency-translated devices, the network analyzer features broadband internal detectors and broadband external detector inputs.

The receiver incorporates digital signal processing and microprocessor control to provide easy operation and measurement improvement.

Two independent display channels and a large CRT display the measured results of one or two receiver channels in several user selectable formats.

Measurement functions are selected with front panel keys and softkey menus. Measurements can be printed or plotted directly with a compatible peripheral. Instrument states can be saved to the internal floppy disk, internal memory disk (RAM disk), or to a compatible external disk drive. Built-in service diagnostics are available to simplify troubleshooting procedures.

Trace math, data averaging, and measurement calibrations provide performance improvement and flexibility. Measurement calibrations consist of normalizing data, utilizing the internal factory calibration, or calibrating with external standards. Measurement calibration reduces the effects of directivity, frequency response, and source match.

Additional Features

- Internal 1.4 MB floppy disk drive permits permanent storage of unlimited amounts of data; reads and writes in both DOS and LIF formats.
- Real-time clock provides easy time and date stamping of hardcopy plots.
- Limit lines quickly and consistently show pass or fail results of device measurements.
- Marker functions allow easy identification of maximum and minimum data points and bandwidths.
- Up to 1601 measurement points provide extremely high frequency resolution.
- Auto sweep time ensures the fastest possible time for the chosen measurement conditions.

- Interpolated error correction preserves the greater accuracy of measurement calibration while allowing changes measurements parameters such as frequency span and number of points.
- Automated operation is possible through IBASIC (an option), HP-IB controllers, the HP Vectra or IBM PC-compatible computers.
- Printer/plotter buffer increases measurement throughput by allowing the network analyzer to make hardcopies and measurements at the same time.
- Rear panel HP-IB, parallel, and RS-232 connectors allow use of a wide variety of peripherals.
- The network analyzer includes a one year return-to-HP service warranty.

Front Panel Features

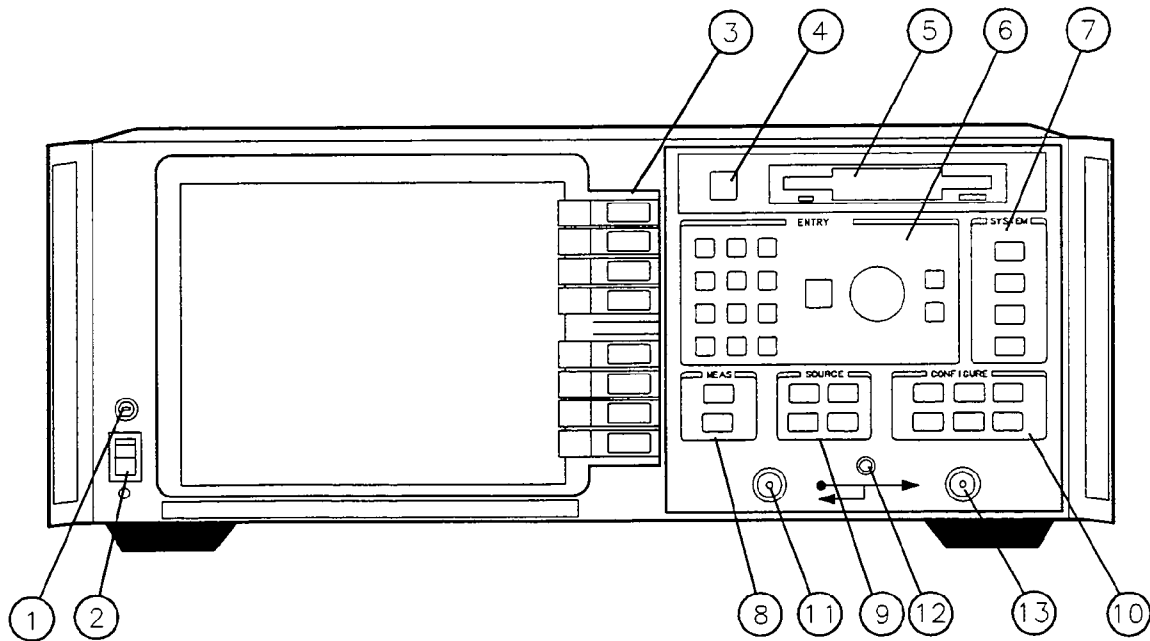

ad63c

Figure 1-2. Front Panel Features

Note



All front and rear panel items are detailed in Chapter 7, "Reference and Menu Map."

1. **Intensity** control adjusts the brightness of the CRT.
2. **Standby|On** switch toggles the instrument between its on and standby states.
3. **Softkeys** perform the named function or present the next menu.

4. **BEGIN** key presents measurement choices in terms of the device under test. If you know more about your device than about this network analyzer, use this key.
5. **Disk Drive** offers permanent information storage capacity limited only by the disks available. In conjunction with IBASIC (optional), it allows the network analyzer to enter a known state or an automated routine at power-on.

Note



See Chapter 7, "Reference and Menu Map," for details on specific keys.

6. **ENTRY** controls (numerical keys, knob, and arrow keys) modify instrument values.
7. **SYSTEM** keys save and recall data and control IBASIC, HP-IB, and service functions.
8. **MEAS** (measurement) keys select the active channel and type of measurement, such as transmission or reflection or power.
9. **SOURCE** keys control the source functions, such as frequency, power, and trigger.
10. **CONFIGURE** keys control the display, marker, and receiver functions.
11. **REFLECTION RF OUT** port outputs the RF signal and also serves as test port for reflection measurements.
12. **PROBE POWER** connector provides fused power for active probes and other devices.
13. **TRANSMISSION RF IN** port receives the RF signal for transmission measurements.

Rear Panel Features

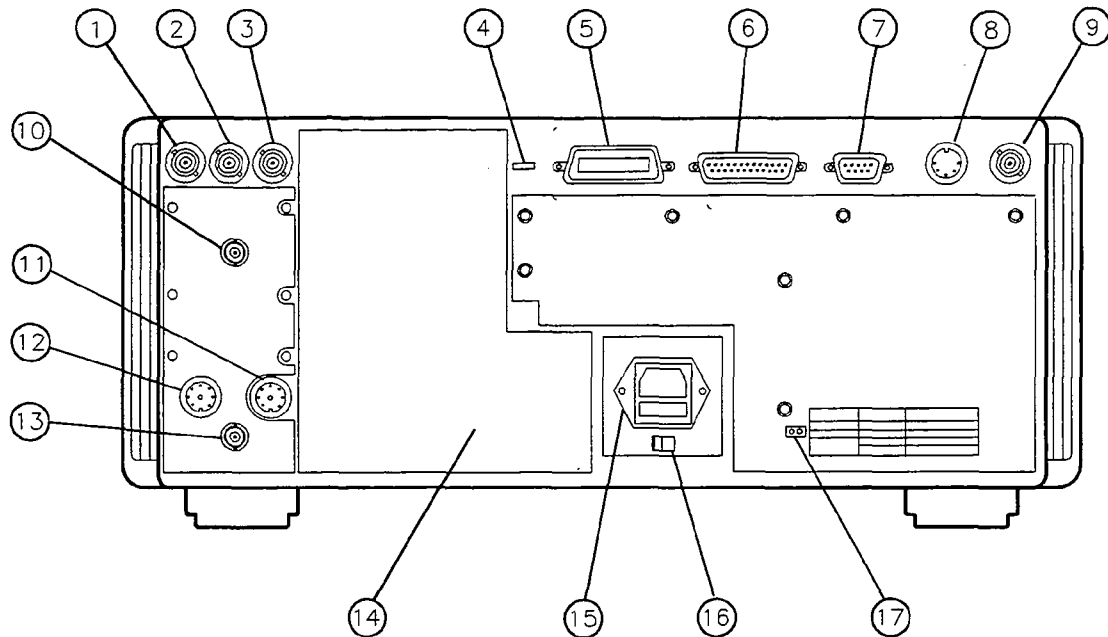

od611a

Figure 1-3. Rear Panel Features

1. **USER TTL IN/OUT BNC** connector provides a bidirectional open-collector TTL signal which can be accessed from IBASIC.
2. **LIMIT TEST TTL IN/OUT BNC** connector provides a bidirectional open-collector TTL high signal. The output goes high when the limit test passes.
3. **EXT TRIG IN/OUT BNC** connector allows external triggering.
4. **TEST RESULTS LED** (behind the cutout) indicates self-test results at power-on.
5. **HP-IB** connector allows communications with compatible devices, including external controllers, printers, plotters, and disk drives.
6. **PARALLEL PORT** connector is used with parallel (or Centronics interface) peripherals such as printers and plotters.
7. **RS-232** connector is used with serial peripherals such as printers and plotters.
8. **DIN KEYBOARD** connector is for the optional keyboard and barcode readers.
9. **VIDEO OUT BNC** connector provides a monochromatic signal for external monitors.
10. **EXT REF IN BNC** connector allows use of an external 10 MHz signal as the frequency reference.

11. **EXT DET X-INPUT** connector powers a compatible external broadband detector and accepts its input for processing and display. Compatible detectors are listed in Chapter 2, "Installing the HP 8711."
12. **EXT DET Y-INPUT** connector, as above.
13. **AUX INPUT BNC** connector is for low frequency, low voltage measurements.
14. **FAN** (not shown) cools the network analyzer by propelling air through it.
15. **POWER CORD RECEPTACLE** is fused and contains a spare fuse.
16. **LINE** voltage selector switch configures the network analyzer for use with available line voltage.
17. **LEDs** indicate the status of the power supply.

Remember, all of the above items are detailed in Chapter 7, "Reference and Menu Map."

Features Available as Options

The following features, capabilities, and services are available as options. The initial code in parentheses is the option number. Options that are available as kits or parts after purchase are noted.

- **HP Instrument BASIC Option (1C2)** harnesses the power of a computer without requiring one. It can easily be programmed to automate the control of the network analyzer and other devices. The option includes an extra 2 MB of memory. It is also available as the HP 86224A IBASIC upgrade kit or as part number 08711-60061.
- **75 Ohm Option (1EC)** provides type-N 75 ohm test port connectors for direct measurements in that impedance.
- **Attenuator Option (1E1)** adds a programmable 60 dB (10 dB steps) attenuator. It is also available as the HP 86223A attenuator upgrade kit or part number 08711-60060.
- **Keyboard Option (1CL)** adds a keyboard, also available as model number HP C1405A option ABA.
- **Rack with Handles Option (1CM)** adds a rack mount kit for rack mounting the network analyzer with its standard handles, also available as part number 08711-60058.
- **Schematic Package Option (0BV)** adds a schematic package for servicing the network analyzer to the component level. It is also available after purchase by ordering the part number listed on the documentation map at the front of this manual.
- **Extra Operating and Service Manuals Option (0BN)** adds a second Operating and Programming Manual and another Service Manual at the time of purchase.

- Service and Support Options, including on-site service and other support options, may be available in some areas. Consult your local HP customer engineer for details.

Previous Firmware Revisions

The previous production firmware revision of this instrument was A.01.52.

Organization of This Manual

Contents consists of a table of contents and a table of figures.

- 1. Brief Description of the HP 8711** describes the instrument, its options and specifications, and this manual.
- 2. Installing the HP 8711** explains how and where to install the network analyzer.
- 3. Quick Start: User's Guide** introduces many of the instrument's features through measurement examples. It is a separately bound, removable booklet.
- 4. Making Measurements** explains how to perform measurement tasks with the instrument. Its procedures are step-by-step, good for learning new tasks.
- 5. Examining Measurement Results** explains how to analyze results with various instrument functions such as markers and limit lines.
- 6. Optimizing Measurements** describes techniques and network analyzer functions that help achieve the best measurement results. Subjects include measurement calibrations, reducing trace noise, and increasing dynamic range and sweep speed.
- 7. Reference and Menu Map** defines in alphabetical order all of the hardkeys, softkeys, connectors, etc. of the instrument. The menu map of the instrument's hardkeys and softkeys is distributed throughout the chapter.
- 8. How the Analyzer Works** reveals how the instrument works and explains major concepts.
- 9. HP-IB Programming** defines all of the instrument's HP-IB mnemonics and lists example programs.

Index alphabetically lists entries from every chapter except Chapter 3, "Quick Start: User's Guide" and Chapter 9, "HP-IB Programming."

Accessories is a place to keep accessory manuals. It also contains a list of Hewlett-Packard's Sales and Service Offices.

Typographical Conventions

Italics are used for book titles and for emphasis.

“Quotes” are used for chapter, section, and paragraph headings.

HARDKEYS are labelled front panel keys.

Softkeys are menu-defined keys next to the CRT.

Instruments Covered by This Manual

This manual covers the instrument that is shipped with it. It also covers instruments with any serial number prefix listed on the title page.

Other instruments may differ from the instruments covered directly by this manual. Those differences are summarized in “Previous Firmware Revisions” in this chapter (above) and in Chapter 8, “Instrument History” of the *HP 8711A RF Network Analyzer Service Manual*.

Manual Set Description

The HP 8711A network analyzer manual set consists of four manuals. Two are standard (supplied with every instrument) and two are optional. The set is graphically depicted in the documentation map at the front of this manual. To explore the manuals further, inspect their title pages, contents and index sections.

HP 8711A System Specifications

Specifications describe the instrument's warranted performance over the temperature range of 25 ± 5 °C. Broadband mode characteristics apply from 10 to 1300 MHz. Narrowband mode characteristics apply from 300 kHz to 1300 MHz.

Source Characteristics

| | |
|------------------------------------|---|
| Frequency | |
| Range | 300 kHz to 1300 MHz |
| Resolution | 1 Hz |
| Accuracy (synthesized) | <5 ppm |
| RF Output Power | |
| Leveled Range | |
| Standard | 0 to +16 dBm, ≤ 1000 MHz 0 to 13 dBm, > 1000 MHz |
| Option 1EC (75 Ω) | 0 to +13 dBm, ≤ 1000 MHz 0 to +10 dBm, > 1000 MHz |
| Option 1E1 (60 dB step attenuator) | reduces maximum RF output power by 3 dB |
| Power Flatness (test port) | |
| Standard | ± 1.0 dB |
| Option 1EC 75 Ω | ± 1.5 dB |
| Option 1E1 (step attenuator) | ± 2.0 dB |
| Option 1EC with 1E1 | ± 2.0 dB |
| Signal purity | |
| Harmonics | < -20 dBc, < 1 MHz < -30 dBc, > 1 MHz |

Specifications

Receiver Characteristics

| | |
|----------------------|--|
| Dynamic Range | |
| Standard | |
| Narrowband mode | >60 dB (+10 to <-50 dBm), ≤5 MHz >90 dB (+10 to <-80 dBm), >5 MHz |
| Broadband mode | >66 dB (+16 dBm to <-50 dBm) |
| Option 1EC (75 Ω) | |
| Narrowband mode | >54 dB (+7 to -47 dBm), ≤5 MHz >84 dB (+7 to -77 dBm), >5 MHz |
| Broadband mode | >63 dB (+16 dBm to <-47 dBm) |

| | |
|-------------------------------|-------------------|
| Maximum Input Level | |
| Narrowband Mode (compression) | +10 dBm (0.8 dB) |
| Broadband Mode (compression) | +16 dBm (0.55 dB) |

Test Set Characteristics*

| | |
|--|-------|
| Reflection Measurements | |
| Test Port Match | 20 dB |
| System Directivity | 40 dB |
| * These characteristics apply for an environmental temperature of 25 ±5 °C with less than 1° deviation from the calibration temperature, at a narrow system bandwidth with spur avoidance activated. Reflection test port characteristics apply at reflection test ports, after a user defined reflection calibration. | |

Dynamic Accuracy (Narrowband)

Dynamic accuracy is the receiver's accuracy versus input power level.

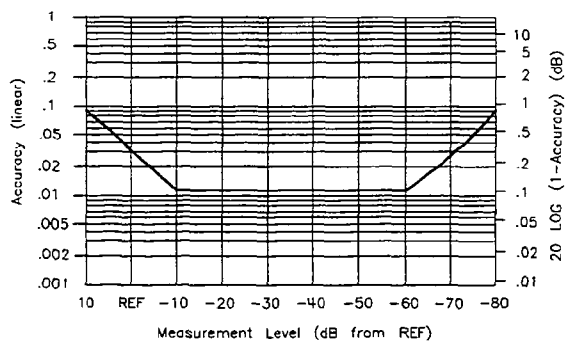

0d6120

**HP 8711A
Supplemental
Operating
Characteristics**

Supplemental operating characteristics are typical but non-warranted performance characteristics. They are representative of most instruments, but not necessarily tested in each. They can be used in applying the instrument. Broadband mode characteristics apply from 10 to 1300 MHz. Narrowband mode characteristics apply from 300 kHz to 1300 MHz.

Source Supplemental Characteristics

| | |
|---------------------------------|---|
| Frequency | |
| Aging | <3 ppm 1st year, <1 ppm/year thereafter |
| Drift | |
| with temperature (0 to 55 °C) | ±5 ppm |
| with 10% change in line voltage | <1 Hz |
| with 3:1 load SWR | <1 Hz |
| External Reference Input | 10 MHz (BNC), >-5 dBm required |

| | |
|-----------------------|---|
| Signal Purity | |
| Non-Harmonic Spurious | |
| >50 kHz from carrier | <-20 dBc, <1 MHz |
| <50 kHz from carrier | <-30 dBc, >1 MHz |
| Phase noise | <-25 dBc, 300 kHz to 1300 MHz |
| Residual AM | -70 dBc/Hz at 10 kHz offset |
| Residual FM | <-50 dBc in 100 kHz bandwidth |
| | <1.5 kHz peak, 30 Hz to 15 kHz post detection bandwidth |

| | |
|-----------------------------|------------|
| Sweep Time | |
| At maximum system bandwidth | |
| Number of Data Points | Sweep Time |
| 51 | <50 ms |
| 101 | <60 ms |
| 201 | <70 ms |
| 401 | <110 ms |
| 801 | <210 ms |
| 1601 | <400 ms |

Specifications

Receiver Supplemental Characteristics

| | |
|----------------------------|---------------------------------------|
| Input Damage Level | +20 dBm, ± 25 Vdc |
| Noise Reduction Techniques | Averaging, system bandwidth reduction |

Test Set Characteristics*

| | |
|---|-------|
| System Directivity (with default calibration) | 30 dB |
| System Directivity (with user calibration) | 40 dB |
| Transmission Measurements | |
| Transmission Port Match | 20 dB |
| Reflection Port Match | 14 dB |
| * These characteristics apply for an environmental temperature of 25 ± 5 °C with less than 1° deviation from the calibration temperature, at a narrow system bandwidth with spur avoidance activated. Reflection test port characteristics apply at reflection test ports, after a user defined reflection calibration. | |

System Accuracy

These characteristics apply for an environmental temperature of 25 ± 5 °C with less than 1° deviation from the calibration temperature, at a narrow system bandwidth with spur avoidance activated. Reflection test port characteristics apply at reflection test ports, after a user defined reflection calibration.

The measurement uncertainty curves utilize an RSS model for the contributions of random errors such as noise, typical connector repeatabilities, and a worst-case model for the contributions of dynamic accuracy and residual systematic errors.

Transmission Accuracy[‡]

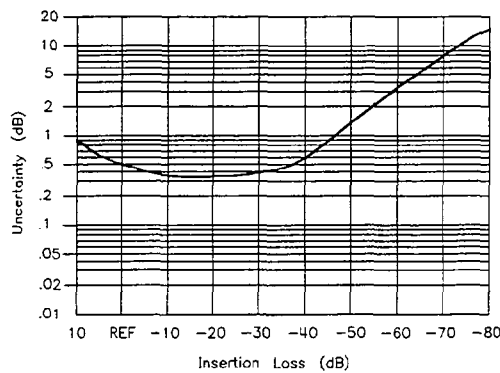

ad613a

[‡] The graphs shown for transmission measurements assume a well-matched device, and do not include errors due to device reflection effects.

Reflection Accuracy[§]

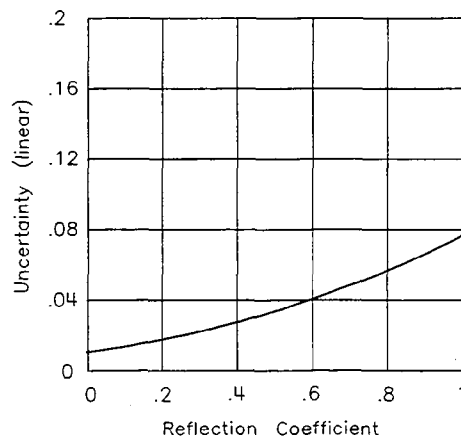

ad614a

[§] The graph for reflection measurement uncertainty applies to a one-port device.

Specifications

Absolute Power Accuracy (broadband)

Total power accuracy = absolute power accuracy + frequency response (± 0.5 dB)

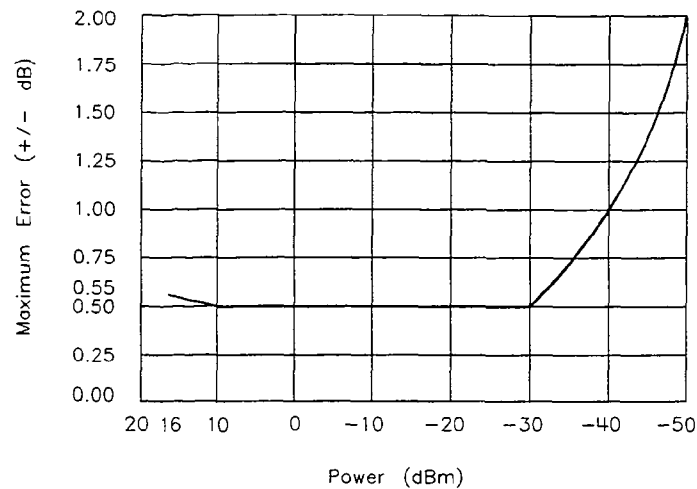

ad615a

Display Characteristics

| | |
|----------------------------|---|
| Display | 23 cm (9 in) diagonal |
| Display Resolution | Vertical 0.003 dB maximum Horizontal 51, 101, 201, 401, 801, 1601 points (user selectable) |
| External CRT Timing | |
| Vertical rate | 60 Hz |
| Horizontal rate | 24.1 kHz |
| Pixel rate | 33.3 MHz |
| Vertical backporch | 90 μ s (nominal) |
| Video level | RS-343A compatible |
| Compatible monitors | multisync, not EGA or VGA |
| Scale Resolution | 0.1, 0.2, 0.5, 1, 2, 5, 10, 20 dB/division |
| Offset Range | +99 dB to -99 dB in 0.01 dB increments |
| Markers | Eight individually controlled markers with 1 Hz frequency resolution |

General Characteristics

| | |
|------------------------------|--|
| Dimensions | 18 cm H × 43 cm W × 48 cm D (7 in × 17 in × 18.75 in) |
| Weight | 20.5 kg (45 lbs) |
| Power | 90 to 132 Vac or 198 to 264 Vac (user selectable) 50 to 60 Hz 230 VA maximum |
| Operating Environment | |
| Operating temperature | 0 to 55 °C |
| Storage temperature | -40 to 70 °C |

Front Panel Connectors

| | |
|--------------------------------|-------------------|
| Connector Type | |
| Impedance | |
| Standard | 50 Ω (nominal) |
| Option 1EC | 75 Ω (nominal) |
| Connector Pin Recession | 0.204 to 0.207 in |

Rear Panel Connectors

| | |
|--|--|
| External Detector Y-input | See Chapter 2 for compatible detectors |
| External Detector X-input | See Chapter 2 for compatible detectors |
| External Trigger In/Out | BNC, TTL open collector |
| Video Out | BNC, conforms to RS-343A standards |
| External Reference In | 50 Ω BNC, >-5 dBm signal |
| Aux Input | User displayable voltage input port |
| Calibrated range | ±10 V |
| Accuracy | ± (3% of reading + 20 mV) |
| Damage level | >14 Vdc (while instrument is on) |
| For best results, observe frequency limits | <250 Hz in wide bandwidth <100 Hz in medium bandwidth <10 Hz in narrow bandwidth |

Installing the HP 8711

Check the Items Supplied with the Instrument

The items supplied with the instrument are listed below.

- HP 8711A RF network analyzer
- BNC test port cable
- Type-N to BNC adapters (two)
- Demonstration filter (for use with the *HP 8711A RF Network Analyzer User's Guide*)
- Example program disks (two)
- Firmware disk (used for service only)
- Correction constants disk (used for service only)
- Power cord
- Operating and programming manual (this manual)
- HP 8711A RF Network Analyzer Service Manual*
- For instruments with IBASIC (Option 1C2):
 - IBASIC manual
 - IBASIC disk

Part numbers for these items are listed under Chapter 7, "Replaceable Parts," in the *HP 8711A RF Network Analyzer Service Manual*.

Select an Appropriate Installation Site

The network analyzer's environmental operating conditions and safety classifications are listed below. Note that measurement calibrations and some instrument specifications require an environmental temperature of $25\text{ }^{\circ}\text{C} \pm 5\text{ }^{\circ}\text{C}$.

- indoor use
- altitude up to 2000 m
- temperature $5\text{ }^{\circ}\text{C}$ to $40\text{ }^{\circ}\text{C}$
- maximum relative humidity 80% for temperatures up to $31\text{ }^{\circ}\text{C}$ decreasing linearly to 50% relative humidity at $40\text{ }^{\circ}\text{C}$
- mains supply voltage fluctuations not to exceed the specified range
- transient overvoltages according to INSTALLATION CATEGORY II, according to IEC 1010
- POLLUTION DEGREE 2 according to IEC 664

Set Up the Instrument

Make sure the serial number on the network analyzer's rear panel matches that of the shipping document.

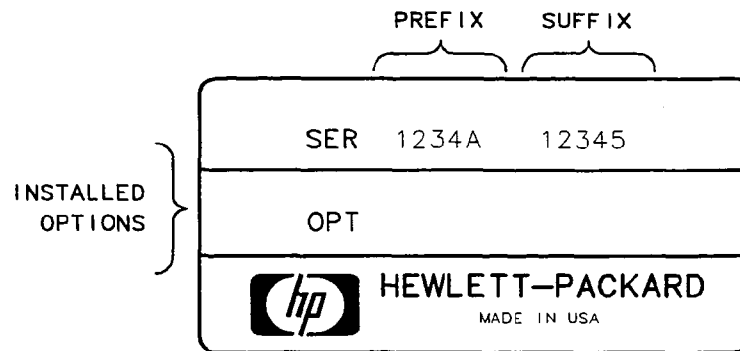

ad517a

Figure 2-1. Serial Number Plate on Rear Panel

To install the network analyzer on a bench, place it on an anti-static mat (such as HP 92175T). Allow at least 2 inches clearance at each side for ventilation.

Use only the recommended rack kits with this instrument; it needs side support rails. Do not mount it by the front panel (handles) only.

To install the network analyzer in the HP 85043D rack, follow the instructions in the rack manual.

To install the network analyzer in other racks, note that they may promote shock hazards, overheating, dust contamination, and inferior system performance. Consult your HP customer engineer about installation, warranty, and support details.

Place other system instruments (computer, printer, plotter, external disk drive) where convenient, within the following HP-IB cable length limits or other control line limits.

Connect Control Cables

The HP-IB port is for use with controllers and peripherals (printers, plotters, and so on). The parallel and RS-232 (serial) are for peripherals only. HP-IB cables can be connected in any order as long as the length limits are observed. Parallel and serial devices often require specific cables—check their manuals for details. Connect the required control cables and secure them. (Tighten the knurled screws or comparable fasteners.)

If your system includes a keyboard, external video monitor, or external detectors, connect them now. (See Figure 2-2.)

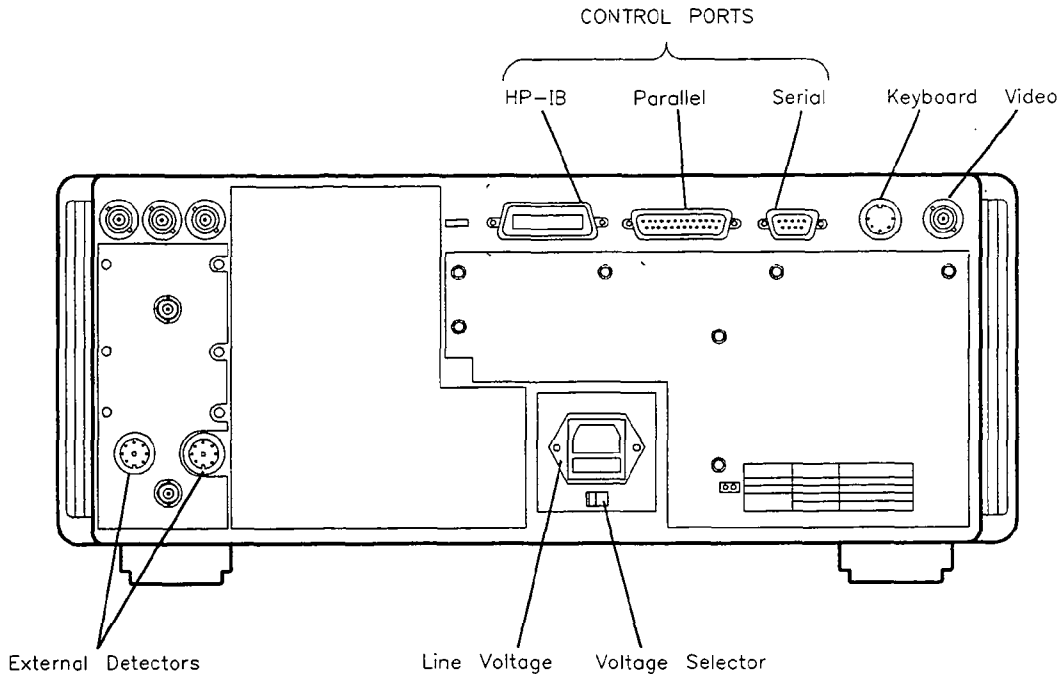

ad616a

Figure 2-2. HP 8711A Network Analyzer Rear Panel Line Module and Selected Connectors

| Instruments in System | Maximum HP-IB Cable Length between Instruments |
|-----------------------|--|
| Two | 4 m |
| Three or more | 2 m |
| Fifteen (max) | 20 m (total) |

Select AC Line Voltage Setting

Confirm that the network analyzer voltage selector (see Figure 2-2) is set to match the AC line voltage before plugging it in. The working fuse and a spare are located in the power cable receptacle.

Warning



Avoid personal injury and instrument damage: use power outlets with a protective earth (third wire) contact only.

| Nominal Setting | AC Line Power |
|-----------------|---------------------------------|
| 115 V | 90 V to 132 V (at 48 to 66 Hz) |
| 230 V | 198 V to 264 V (at 48 to 66 Hz) |

If the AC line voltage is not within either range, use an autotransformer.

Caution



Avoid instrument damage: make certain the autotransformer provides third wire continuity to earth ground.

Plug In AC Line Power Cables and Turn On Instruments

Use the three-wire power cable supplied with each instrument. This cable grounds the instrument (as required) when connected to an appropriate outlet. To order power cables with different plugs, contact your local HP customer engineer.

Turn on the line switch of each instrument (network analyzer last). Check that each instrument is on and has passed its self-test, if any. If an instrument malfunctions, refer the instrument's manual (for the network analyzer, refer to the *HP 8711A RF Network Analyzer Service Manual*).

Note



Turning on the network analyzer at the same time as other devices on the HP-IB may lock up the network analyzer. If calculating correction constants is displayed for an abnormally long time, cycle the line power to the network analyzer.

Set HP-IB Addresses

To communicate via HP-IB, each device must have a unique address and the network analyzer must recognize each address. To check or set each device's actual address, refer the instrument's manual (most addresses are set with switches).

To check or set the device's recognized address, follow the instructions below:

- **External Disk Drive:** on the network analyzer, press **SAVE RECALL** **Select Disk Configure Ext Disk Ext Disk Address**. The default setting is 0 (zero). To select another address, enter the number and press **Enter**.
- **Printer:** press **HARDCOPY** **Select Copy Port**. Use the RPG knob to highlight the line that reads HP PRINTER PCL HP-IB. Press **Select**. The second line of the screen displays the address (default is 5). Most printers are factory set to address 1 (one). To change the recognized address, press **Hardcopy Address** **number** **Enter Select**.
- **Plotter:** press **HARDCOPY** **Select Copy Port**. Use the RPG knob to highlight the line that reads HP PLOTTER HPGL HP-IB. Press **Select**. The second line of the screen displays the address (default is 5). Most plotters are factory set to address 5 (five), so changing the address is probably not necessary. To change the recognized address, press **Hardcopy Address** **number** **Enter Select**.

- **HP 8711:** press **SYSTEM OPTIONS** **HP-IB HP8711 Address**. The network analyzer's address will appear (default is 16). To change the address, press **number** **Enter**.

Note



Only one hardcopy address can be set at a time. Changing the printer address, for example, changes the plotter to the same address.

Configure Peripheral Settings

If your system uses serial or parallel peripherals, follow the guidelines below to configure the system. Refer to the peripheral's manual for correct cables and settings. The parallel port pinout is a standard Centronics DB-25 pinout as explained in Chapter 7, "Reference and Menu Map."

- **Serial Devices:** press **HARDCOPY** **Select Copy Port**, use the entry controls to highlight your type of printer or plotter and press **Select**. If the baud rate or handshake at the top of the screen are incorrect, use the softkeys to change them.
- **Parallel Devices:** press **HARDCOPY** **Select Copy Port**, use the entry controls to highlight your type of printer or plotter and press **Select**.

See Service Manual for Recommended Test Equipment

Refer to the *HP 8711A RF Network Analyzer Service Manual* for a list of test equipment recommended for performance testing, troubleshooting, and repairing the instrument.

Operation

For an introduction to operating the network analyzer, refer to the *HP 8711A RF Network Analyzer User's Guide* and perform the measurement examples as outlined. If you are familiar with network analyzers in general and want to begin measuring your device, turn to Chapter 4, "Making Measurements."

Measurement Accessories Available

Most measurement systems will use one or more of the following accessories.

Calibration Kits

The following calibration kits include the calibration standards required to perform a measurement calibration in the connector type and impedance indicated.

- HP 85032B 50 ohm type-N calibration kit
- HP 85032E 50 ohm type-N calibration kit (economy)
- HP 85033C Option 001 3.5 mm calibration kit
- HP 85036B 75 ohm type-N calibration kit
- HP 85036E 75 ohm type-N calibration kit (economy)

Adapter Kits

These adapter kits provide the adapters required to make measurements in the connector type and impedance indicated.

- HP 11853A 50 ohm type-N accessory kit
- HP 11854A 50 ohm BNC accessory kit
- HP 86212A 50 ohm type-N to TNC adapter kit
- HP 11878A 3.5 mm accessory kit
- HP 11852B 50 to 75 ohm minimum loss pad
- HP 11855A 75 ohm type-N accessory kit
- HP 11856A 75 ohm type-N to 75 ohm BNC accessory kit
- HP 86211A 75 ohm type-N to type-F adapter kit

Test Port Cables

- HP 8120-1839 50 ohm BNC 24 inch test port replacement cable
- HP 8120-4781 50 ohm type-N test port cable
- HP 5063-0061 75 ohm BNC 24 inch test port replacement cable
- HP 8120-2408 75 ohm type-N test port cable

HP-IB Cables

| Cable | Length |
|-----------|-----------|
| HP 10833A | 1.0 meter |
| HP 10833B | 2.0 meter |
| HP 10833C | 4.0 meter |
| HP 10833D | 0.5 meter |

**External Detection
Devices**

- HP 86200A 50 ohm RF scalar detector
- HP 86205A 50 ohm RF bridge
- HP 85024A high frequency probe
- HP 86201A 75 ohm RF scalar detector
- HP 86207A 75 ohm RF bridge

Making Measurements

This chapter describes how you can configure various measurements using the **BEGIN** key and provides examples of measurements made with the HP 8711A network analyzer.

| | |
|---|------|
| Configuring Measurements from the BEGIN Key | 4-1 |
| To Configure Measurements | 4-1 |
| Measuring Devices with an HP 8711A Network Analyzer | 4-3 |
| To Make a Transmission Measurement | 4-5 |
| To Make a Reflection Measurement | 4-10 |
| To Make a Power Measurement | 4-16 |
| To Make a Conversion Loss Measurement | 4-19 |

Configuring Measurements from the **BEGIN** Key

This section shows you how to use the **BEGIN** key to configure the network analyzer for measuring the following devices:

- amplifiers
- filters
- broadband passive devices
- mixers

Configuring basic measurements from the **BEGIN** key helps you ensure correct instrument set up. The network analyzer guides you through the initial steps and configures the HP 8711A network analyzer for the device type you select. The network analyzer also scales the measurement trace to fit on the screen (autoscale) and places a marker at the maximum value for transmission measurements, or the minimum value for reflection measurements. Use **BEGIN** for channel 1 only.

To Configure Measurements

This procedure shows you how to configure the network analyzer for measurements.

1. Press **PRESET**.
2. Connect your test device to the network analyzer.
3. Press **BEGIN** and then press the key that corresponds to the device you are measuring (amplifier, filter, broadband passive device).
4. Press the key that corresponds to the measurement you want to make.

- Press **Transmissn** if you want to measure the transmission characteristics of an amplifier, filter, or broadband passive device.
- Press **Reflection** if you want to measure the reflection characteristics of your device.
- Press **Power** if you want to measure the output power of an amplifier.
- Press **Conversion Loss** if you want to measure the conversion loss characteristics of a mixer.

Depending on your measurement parameter, the network analyzer is set to one of the following configurations:

Measurement Configurations from the **(BEGIN) Key**

| | Transmission | Reflection | Power | Conversion Loss |
|--------------------------|---------------------|--------------------|-----------------|------------------------|
| Frequency Range | 0.300 MHz—1300 MHz | 0.300 MHz—1300 MHz | 10 MHz—1300 MHz | 10 MHz—1300 MHz |
| Power Level | 0 dBm | 0 dBm | 0 dBm | 0 dBm |
| Channel 1 | Transmission | Reflection | Power | Conversion Loss |
| Channel 2 | Off | Off | Off | Off |
| Format | Log Mag | Log Mag | Log Mag | Log Mag |
| Number of Points | 201 | 201 | 201 | 201 |
| Sweep Time | 114 ms | 114 ms | 114 ms | 114 ms |
| Sweep Triggering | Continuous | Continuous | Continuous | Continuous |
| Detection Mode | Narrowband | Narrowband | Broadband | Broadband |
| Measurement Paths | B/R | A/R | B* | B*/R* |
| Averaging | Off | Off | Off | Off |
| System Bandwidth | Medium | Medium | Medium | Medium |

For procedures of example measurements, refer to the following section.

Measuring Devices with an HP 8711A Network Analyzer

This section describes what the network analyzer is measuring in each measurement type and provides example procedures. The procedures show you how to make each type of measurement as well as how to use network analyzer features to improve your measurement results.

Transmission and Reflection Measurements

The HP 8711A network analyzer has an RF signal source that produces an incident signal that you use as a stimulus to measure your test device. Your device responds by reflecting a portion of the incident signal and transmitting the remaining signal. Figure 4-1 shows how a device under test (DUT) responds to an RF source stimulus.

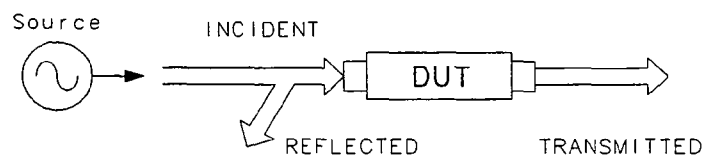

ad620a

Figure 4-1. Device under Test Response to an RF Signal

The transmitted signal (input B) and reflected signal (input A) are measured by comparing the signal to the incident signal. The network analyzer can measure the incident signal level by taking a small portion of it to use as a reference signal (input R). The network analyzer sweeps the source frequencies, resulting in a measured and displayed response of your test device. Figure 4-2 shows the transmitted, reflected, and reference signal inputs.

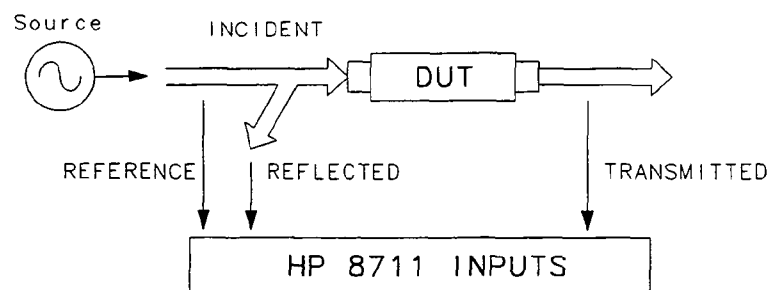

ad621a

Figure 4-2. Receiver Inputs for Transmitted, Reflected, and Reference Signals

Measurement Detection Modes

The network analyzer receiver has two signal detection modes:

- broadband detection mode
- narrowband detection mode

When the network analyzer is in the broadband detection mode, all signals present at the input are measured over the full frequency range. This enables the characterization of frequency translation devices such as mixers, receivers, and tuners, where the RF input and output frequencies are not the same. Figure 4-3 shows the incident signal for broadband detection input as B^* , and the reference signal as R^* .

When the network analyzer is in the narrowband detection mode, the receiver is tuned to the source frequency. This technique provides greater dynamic range by decreasing the receiver's bandwidth. Figure 4-3 shows incident signal for narrowband detection input as B , and the reference signal as R .

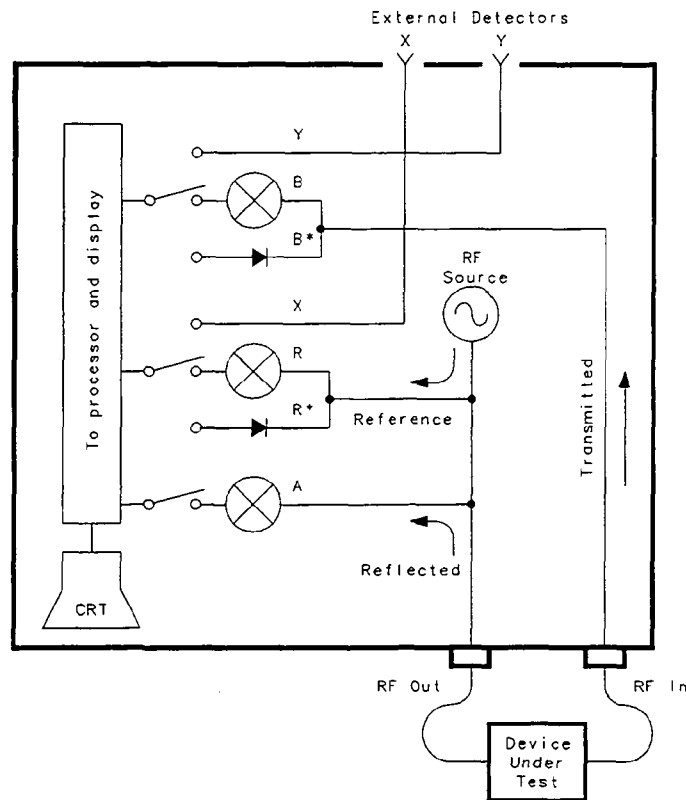

ad622a

Figure 4-3. Broadband and Narrowband Detection Mode Inputs

Power and Conversion Loss Measurements

When you measure a device for absolute output power, the network analyzer uses the broadband detection mode and measures only the transmitted signal (B^*) which is the combined power of the fundamental and all of the source harmonics.

When you are characterizing a device's conversion loss, the network analyzer again uses broadband detection but measures the transmitted signal (B^*) compared to the reference signal (R^*), since the input and output signals are at different frequencies. Because the broadband detection mode combines the power of the fundamental, all the source harmonics, and any mixing products, you should use a filter to remove the unwanted mixing products (RF+LO).

Network Analyzer Input Channels

The following table shows the correlation between the measurement parameters, the network analyzer input channels, and signals.

| Measurement | Input Channels | Input Signals |
|-----------------|----------------|--------------------------------|
| Transmission | B/R | transmitted/incident |
| Reflection | A/R | reflected/incident |
| Power | B^* | broadband transmitted |
| Conversion Loss | B^*/R^* | broadband transmitted/incident |

To Make a Transmission Measurement

In this example you measure the bandpass filter that was shipped with your HP 8711A network analyzer. (For a description of a transmission measurement, refer to "Measuring Devices with an HP 8711A Network Analyzer" above.) This procedure shows you how to make a basic transmission measurement and then shows you how to increase the network analyzer's dynamic range. Since the dynamic range is the difference between the network analyzer's maximum allowable input level and its broadband noise floor, the techniques applied in this procedure either affect the receiver's input power or noise floor.

The techniques you can use for increasing the network analyzer's dynamic range are listed below:

- increasing receiver input
- changing system bandwidth
- adding measurement averaging

Note



You can use the techniques above singularly, or in any combination. Be aware that using several at a time can increase measurement time.

Setting Up the Measurement

1. Connect the equipment as shown in Figure 4-4.

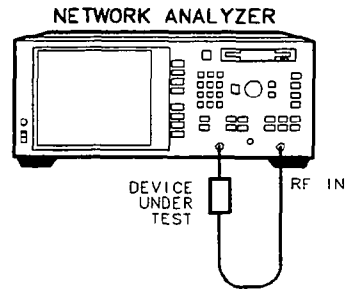

ad623a

Figure 4-4. Equipment Setup for a Transmission Measurement

2. Press the following keys on the network analyzer:

PRESET

CHAN 1

Transmissn

3. If you have any adapters or additional cables in your measurement setup, you may want to make a measurement calibration. Refer to Chapter 6, “Optimizing Measurements,” for information to determine if your test setup requires a measurement calibration.

Displaying the Measurement Result

4. To view the entire measurement trace on the screen, press:

SCALE

Autoscale

Figure 4-5 shows an example result of a transmission measurement.

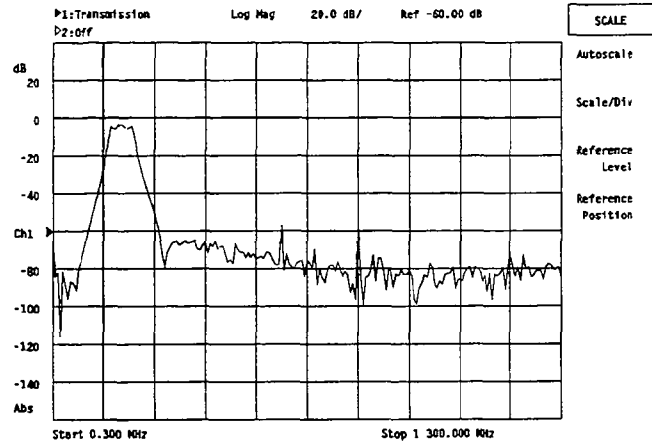

Figure 4-5. Example of a Transmission Measurement

Increasing Dynamic Range by Increasing Receiver Input

5. Press the following keys on the network analyzer:

POWER

Level

10

dBm

By increasing the source power, you ensure the filter's transmitted power is within the network analyzer's measurement range.

Figure 4-5 shows the dynamic range comparison between the measurement made at the default power of 0 dBm and Figure 4-6 shows the measurement made with the power increased to 10 dBm. Note that the trace in Figure 4-6 beyond the bandpass of the filter has decreased by approximately 10 dB as compared to Figure 4-5.

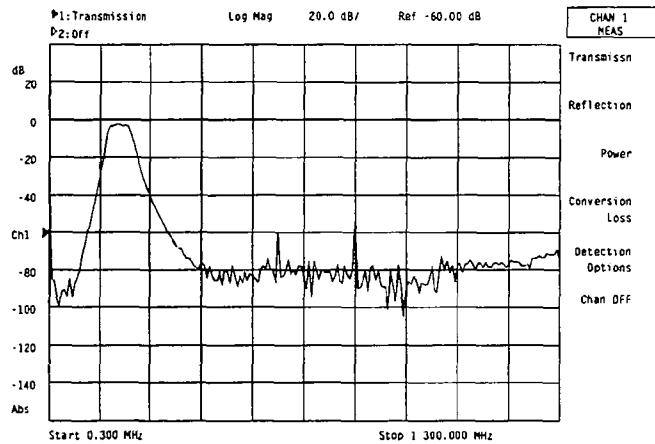

Figure 4-6. Effects of Changing Receiver Input Power on Dynamic Range

Increasing Dynamic Range by Narrowing System Bandwidth

6. Press the following keys on the network analyzer:

AVG

System Bandwidth

Narrow

When you narrow the system bandwidth, the network analyzer lowers the noise floor. Figure 4-7 shows how narrowing the system bandwidth smooths the trace and affects the dynamic range.

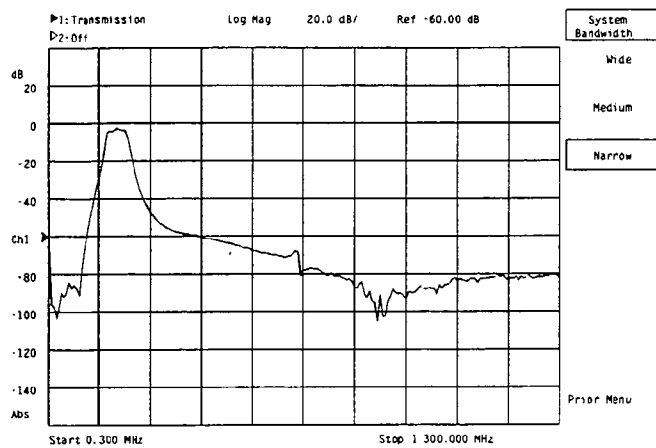

Figure 4-7. Effects of a System Bandwidth on Dynamic Range

Increasing Dynamic Accuracy by Adding Measurement Averaging

7. Press the following keys on the network analyzer:

AVG

Average Factor

16

ENTER

Average ON/off

When you add averaging, the network analyzer averages successive measurement traces to remove the effects of random noise. By increasing the number of averages (averaging factor), you lower the noise floor. Figure 4-8 shows how adding averaging affects the dynamic range.

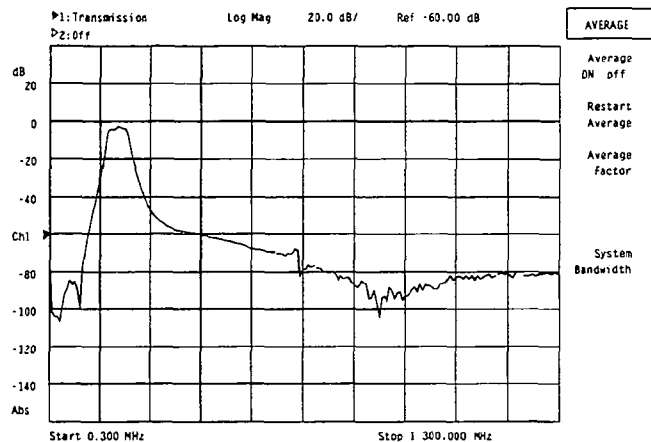

Figure 4-8. Effects of Adding Averaging on Dynamic Range

To Make a Reflection Measurement

In this example you measure the bandpass filter that was shipped with your HP 8711A network analyzer. (For a description of a reflection measurement, refer to “Measuring Devices with an HP 8711A Network Analyzer” at the beginning of this section.) This procedure shows you how to make a basic reflection measurement and then shows you how to improve the measurement accuracy by improving the network analyzer’s directivity, match, and tracking.

The techniques you can use for improving the measurement accuracy are listed below:

- making a normalization calibration
- making a 1-port calibration

Normalization is the simplest type of calibration. This calibration stores data into the network analyzer memory and divides subsequent measurements by the stored data to remove frequency response errors. You can use this type of calibration for both narrowband and broadband measurement.

A 1-port calibration uses an error correction array to correct for directivity, source match, and frequency response errors in narrowband measurements.

Setting Up the Measurement

1. Connect the equipment as shown in Figure 4-9.

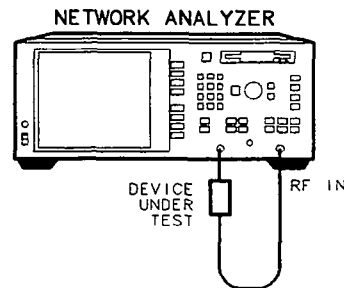

cd623a

Figure 4-9. Equipment Setup for a Reflection Measurement

2. Press the following keys on the network analyzer:

PRESET
CHAN 1
Reflection

Displaying the Measurement

3. To view the filter reflection measurement, press:

SCALE
Autoscale

Figure 4-10 shows an example reflection measurement of a filter.

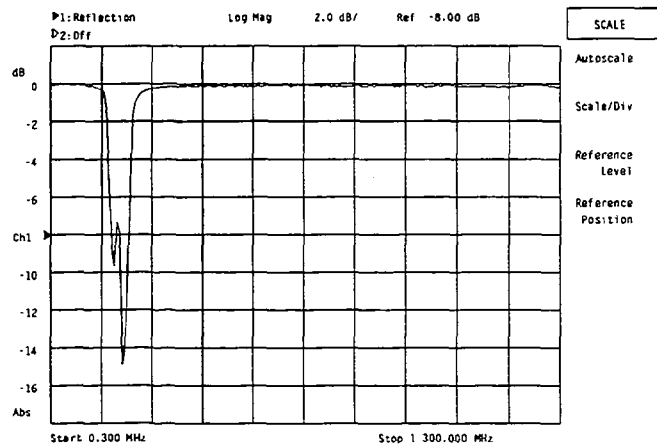
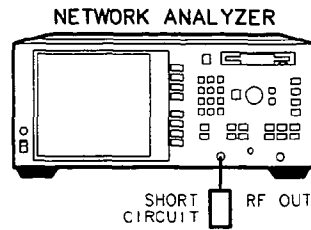

Figure 4-10. Example of a Reflection Measurement

Improving Accuracy by Making a Normalization Calibration

4. Remove your test device from the measurement setup and connect a short circuit calibration standard to the REFLECTION port, as shown in Figure 4-11. (The calibration standard is part of the HP 85032B/E 50 Ω or HP 85036B/E 75 Ω calibration kit.)



ad624a

Figure 4-11. Connections for a Reflection Measurement Normalization

5. Press the following keys:

CAL
Normalize

6. Reconnect your test device in the original measurement setup.

Figure 4-12 shows example results of a filter reflection measurement with a normalization calibration.

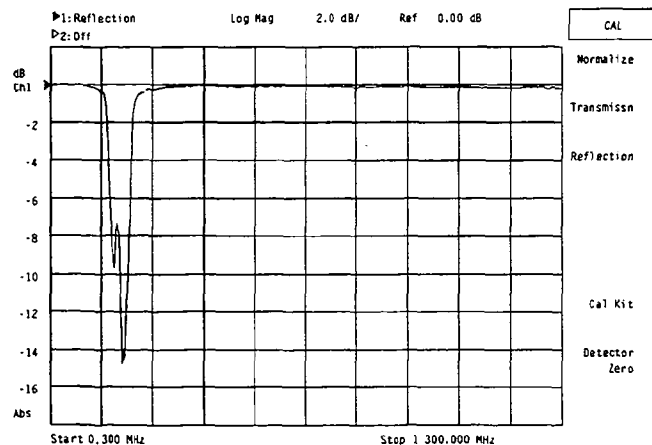
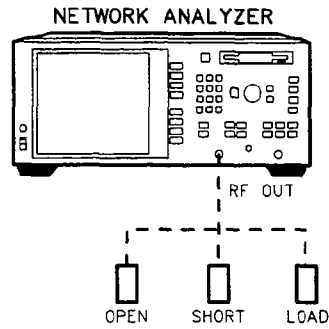

Figure 4-12. Example of a Reflection Measurement with a Normalization Calibration

Improving Accuracy by Making a 1-Port Calibration

7. Remove your test device from the measurement setup and connect an open calibration standard to the REFLECTION port, as shown in Figure 4-13. (The calibration standard is included in the HP 85032B/E 50 Ω or HP 85036B/E 75 Ω calibration kit.)



ad625a

Figure 4-13. Connections for Making a 1-Port Measurement Calibration

8. Press the following keys:

CAL
Reflection
Full Band
Measure Standard

Wait for the network analyzer to measure the calibration standard.

9. When prompted, connect a short circuit to the REFLECTION port and press:

Measure Standard

10. When prompted, connect a load to the REFLECTION port and press:

Measure Standard.

The message Calculating correction coefficients ... is repeatedly displayed on the screen after the load is measured.

11. When the message Calculation Complete is displayed, reconnect your test device in the measurement setup.

Figure 4-14 shows an example result of a filter reflection measurement with a 1-port calibration.

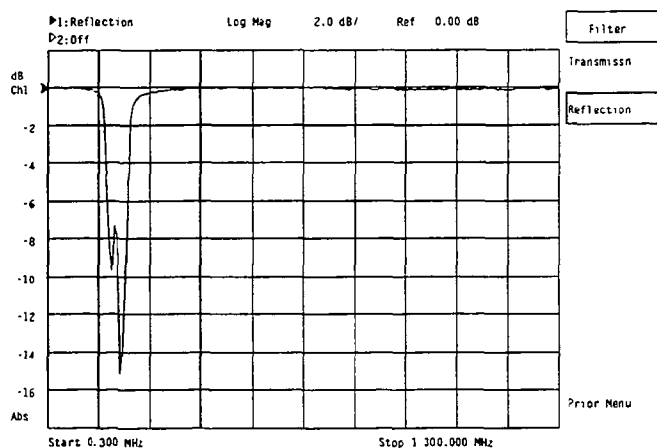
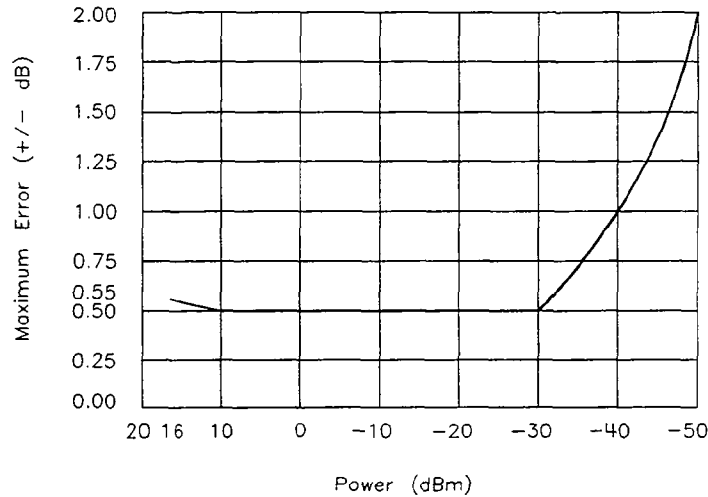

Figure 4-14. Example of a Reflection Measurement with a 1-Port Calibration

To Make a Power Measurement

In this example measurement you use the HP 8711A network analyzer's broadband receiver mode to measure the total output power of an amplifier. (For a description of a power measurement, refer to "Measuring Devices with an HP 8711A Network Analyzer" at the beginning of this section.) This procedure also shows you how to improve the accuracy of your power measurement by keeping the network analyzer input within the region of the receiver's most linear operation. Figure 4-15 depicts the HP 8711A network analyzer power accuracy versus input power.



ad615a

Figure 4-15. HP 8711A Network Analyzer Absolute Power Accuracy (10 to 1300 MHz)

Setting Up the Measurement

1. Connect the equipment as shown in Figure 4-16.

Caution



Damage will occur if the receiver input power is >20 dBm. If necessary, use an input attenuator.

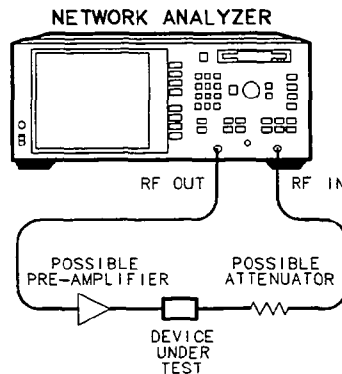

ad627a

Figure 4-16. Equipment Setup for a Power Measurement

2. Press the following keys on the network analyzer:

PRESET
CHAN 1
Power

3. If you have a preamplifier or attenuator in your measurement setup, you may want to make a measurement calibration. Refer to Chapter 6, "Optimizing Measurements," for information on determining if your setup requires a calibration.

Displaying the Measurement

4. To view the measurement trace, press:

SCALE
Autoscale

Figure 4-17 shows the results of an example power measurement.

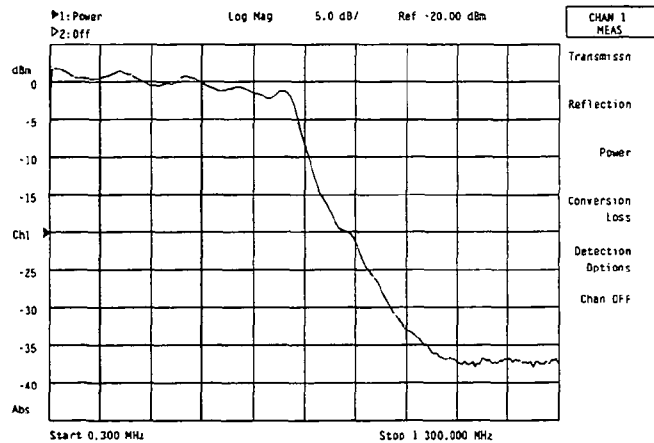

Figure 4-17. Example of a Power Measurement

Notice that part of the displayed measurement is below -30 dBm, which is outside of the region of the receiver's most linear operation.

Improving Power Accuracy by Increasing Receiver Input

5. Press the following keys:

POWER
Level
10
dBm

By increasing the source power, you made the network analyzer's input power in the region of the receiver's most linear operation.

6. To view the entire measurement trace, press:

SCALE **Autoscale**

Figure 4-18 shows an example of a power measurement with increased power measurement accuracy.

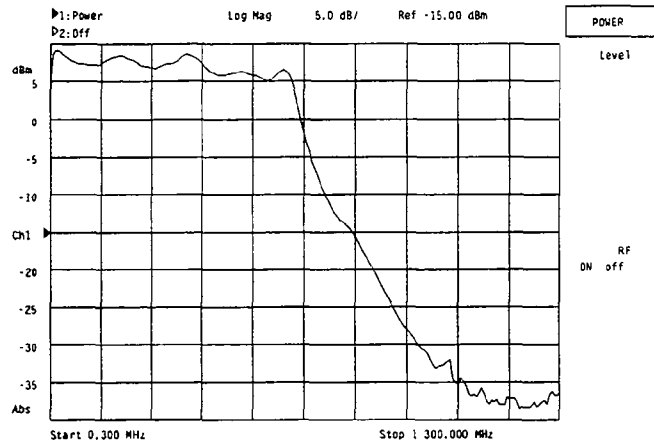

Figure 4-18. Example of a Power Measurement with Increased Power Accuracy

Caution



If you set the network analyzer RF output higher than +10 dBm, the source could go into compression. (See Chapter 1, "Brief Description of the HP 8711," for source and receiver specifications.) If your test device requires drive power >+10 dBm, use a preamplifier in your measurement setup. However, do not exceed the receiver damage limit of +20 dBm.

To Make a Conversion Loss Measurement

In this example measurement you use the HP 8711A network analyzer's broadband receiver mode to measure the conversion loss of a broadband mixer. (For a description of a conversion loss measurement, refer to "Measuring Devices with an HP 8711A Network Analyzer" at the beginning of this section.) This procedure also shows you how to increase the network analyzer's dynamic range. Since the dynamic range is the difference between the network analyzer's maximum allowable input level and its broadband noise floor, the techniques applied in this procedure affect either the receiver's input power or noise floor.

The techniques you can use for increasing dynamic range are listed below:

- increasing receiver input
- changing system bandwidth
- adding measurement averaging

Setting Up the Measurement

1. Connect the equipment as shown in Figure 4-19.

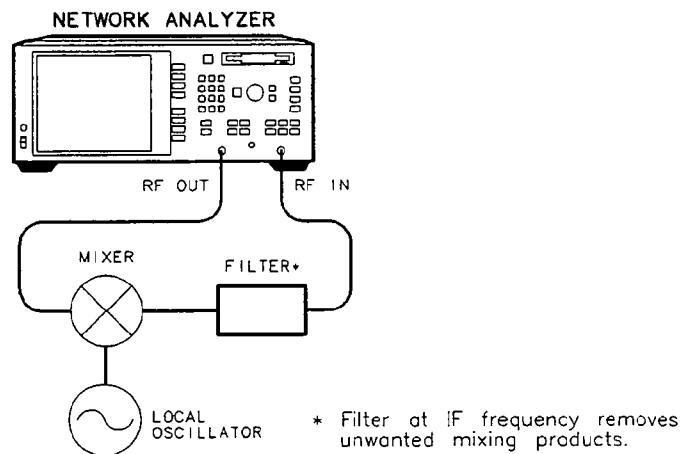

ad628a

Figure 4-19. Equipment Setup for a Mixer Conversion Loss Measurement

2. Press the following keys:

PRESET

CHAN 1

Conversion Loss

Figure 4-20 shows an example of a mixer conversion loss measurement.

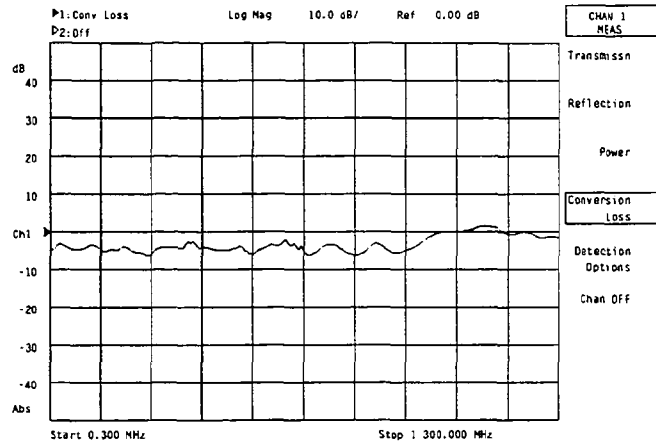

Figure 4-20. Example of a Conversion Loss Measurement

Increasing Dynamic Range by Increasing Receiver Input

3. Press the following keys:

POWER

Level

10

dBm

By increasing the source power, you ensure the mixer's transmitted power is within the network analyzer's measurement range. Figure 4-20 shows the measurement made with the source at the default power of 0 dBm. Figure 4-21 shows the measurement made with the source power increased by 10 dBm.

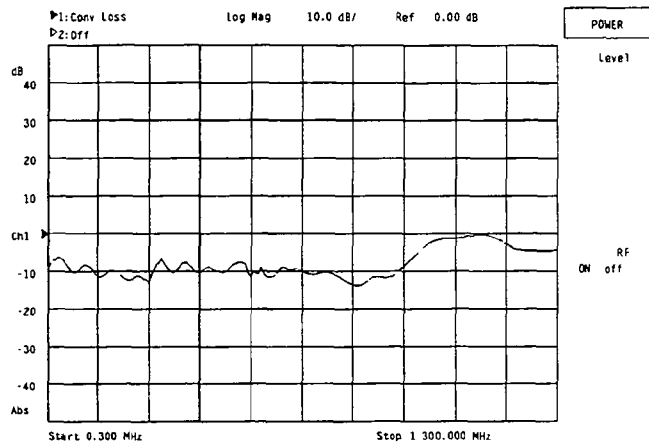

Figure 4-21. Effects of a Receiver Input Power on Dynamic Range

Increasing Dynamic Range by Narrowing System Bandwidth

4. Press the following keys:

AVG

System Bandwidth

Narrow

When you narrow the system bandwidth, you lower the network analyzer's noise floor. Figure 4-22 shows how the narrowing of the system bandwidth affects the dynamic range. The instrument default setting is medium bandwidth.

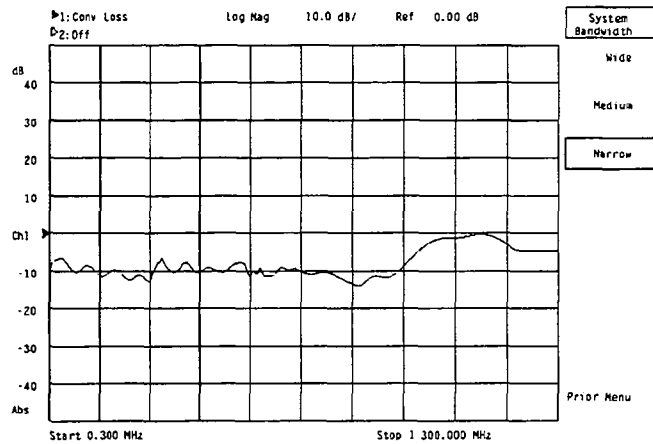

Figure 4-22. Effects of a System Bandwidth on Dynamic Range

Increasing Dynamic Accuracy by Adding Measurement Averaging

5. Press the following keys:

AVG

Average Factor

16

ENTER

Average ON/off

When you add averaging, the network analyzer averages successive measurement traces to remove the effects of random noise. By increasing the number of averages (averaging factor), you lower the noise floor. Figure 4-23 shows how adding measurement averaging affects the dynamic range.

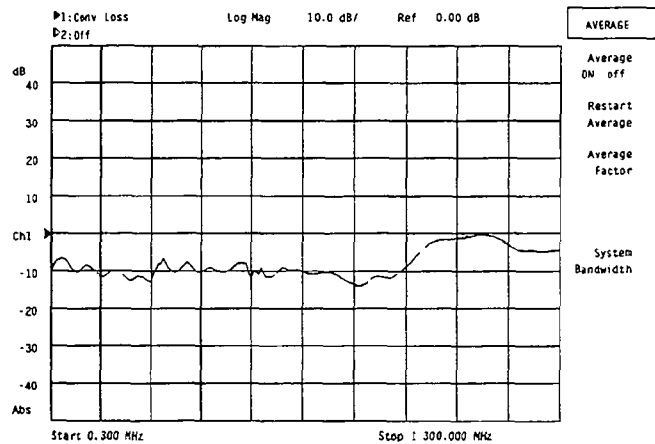

Figure 4-23. Effects of Adding Averaging on Dynamic Range

Examining Measurement Results

After you make a measurement with the HP 8711A network analyzer, you can analyze the results with various functions in the network analyzer. This chapter consists of examples that describe how to use the network analyzer's functions for extracting data from your measurement results.

| | |
|---|------|
| Activating Marker Functions | 5-2 |
| To Search for Specific Values on the Measurement Trace | 5-2 |
| To Measure Values in Reference to Other Values | 5-5 |
| Saving and Recalling Measurement Results | 5-5 |
| To Save a File | 5-6 |
| To Recall from a Disk or Internal Memory | 5-7 |
| To Make and Change Directories | 5-8 |
| To Format a Floppy Disk | 5-9 |
| Printing and Plotting Measurement Results | 5-11 |
| To Connect the Printer or Plotter to the HP 8711A Network Analyzer | 5-11 |
| To Configure the HP 8711A Network Analyzer Hardcopy Port 5-11 | |
| To Define the Hardcopy Device Settings | 5-13 |
| To Define the Hardcopy Output | 5-15 |
| To Title Displayed Measurement Results | 5-17 |
| To Generate a Hardcopy Output | 5-17 |
| To Save a Plot File to Disk | 5-18 |
| Limit Testing | 5-18 |
| To Create a Limit Test | 5-19 |
| To Determine if a Measurement Is Out-of-Limits | 5-22 |
| To Edit Limits | 5-22 |
| Displaying Measurement Traces | 5-23 |
| To Display Measurements at Different Power Levels | 5-23 |
| To Display Different Characteristic Measurements | 5-24 |
| Viewing the Ratio of Two Measurement Traces | 5-26 |

Activating Marker Functions

You can use markers to examine your measurement results in the following ways:

- obtain numerical readings of measured values
- search the trace for specific values
- reference a marker for relative measurements

Markers have a stimulus value (the x-axis value) and a response value (the y-axis value). When a marker is turned on and the marker function is active, its stimulus value is displayed in the active entry area and can be controlled with the front panel knob, the arrow keys, or the numeric keypad. For additional information, see “marker” in Chapter 7, “Reference and Menu Map.”

To Search for Specific Values on the Measurement Trace

You can use markers to search a measurement trace for the maximum or minimum point. You can also use marker functions to calculate the bandwidth and Q values of a bandpass filter response.

Note



The following procedure assumes you have a filter measurement displayed on the network analyzer. Refer to “To Make a Transmission Measurement” in Chapter 4, “Making Measurements,” for an example procedure that shows you how to measure a filter.

Viewing the Entire Measurement Trace Display

1. Press **SCALE** **Autoscale** to more easily view the measurement trace.

Searching for Maximum and Minimum Values

2. Press **MARKER** **Marker Search Tracking ON Mkr > Min** to move marker 1 (the active marker) to the minimum value on the trace.

The tracking function is turned on to continuously update the marker search with each sweep.

3. Press **Prior Menu :2 Marker Search Mkr > Max** to move marker 2 (the active marker ∇) to the maximum value on the trace.

Figure 5-1 shows the network analyzer tracking (updating) the maximum and minimum points with each new sweep. This function can be used for tuning a filter.

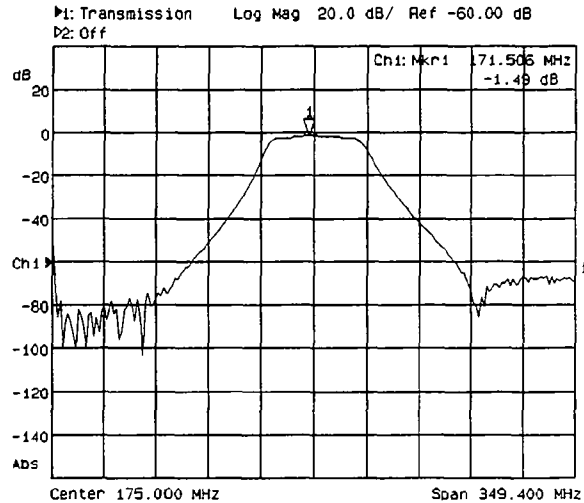

Figure 5-1. Markers Searching for Minimum and Maximum Values with Tracking On

Searching for Target Values

4. Press **Prior Menu All off 2 Marker Search Target Search**.
5. Press **Target** to choose the target level and enter the target value. (The network analyzer default value is -3 dB.)
6. Press **Search Left** and notice the marker moves to the first occurrence of the target value to the left. The target value is in reference to the marker value.
7. Press **Search Right** and notice the marker moves to the first occurrence of the target value to the right.

Each time you press **Search Right** or **Search Left** the marker moves to the next occurrence of the target level.

The search left and search right options are for analyzing multiple occurrences of the target value.

Searching for Bandwidth Values

1. Press **(MARKER) All Off Marker Search Bandwidth**.

Note



Use the bandwidth function for transmission or power measurements in log mag format.

The bandwidth search feature analyzes a bandpass filter and calculates the bandwidth, center frequency, and Q (quality factor) for the specified bandwidth level. The bandwidth information is displayed in the upper-right corner of the network analyzer screen. The bandwidth feature puts marker 1 in delta marker mode. (See the following paragraphs for details.)

- Press **[6]** and press **[ENTER]** to change the -3 dB target to -6 dB.

Each marker's dedicated use is listed in the following table. Channel 1 markers are also shown in Figure 5-2.

| Dedicated Use | Channel 1 | Channel 2 |
|-------------------------------------|-----------|-----------|
| maximum power value | marker 1 | marker 2 |
| filter center frequency | marker 3 | marker 4 |
| bandwidth cutoff point on the left | marker 5 | marker 7 |
| bandwidth cutoff point on the right | marker 6 | marker 8 |

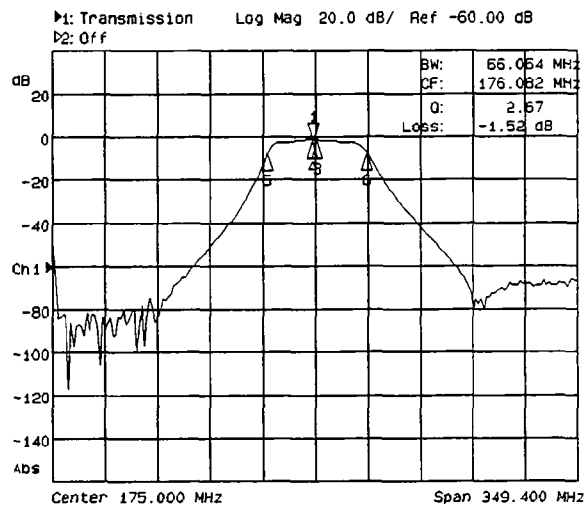

Figure 5-2. Markers Searching for Bandwidth Values

- If you want to change the marker frequency resolution, press **[FREQ]** **Disp Freq Resolution** and enter a different resolution value.

Note



When you make a hardcopy of your measurement results that contain displayed markers, you can choose to have a marker table appear on the hardcopy. Refer to “Printing and Plotting Measurement Results” later in this chapter.

To Measure Values in Reference to Other Values

In this procedure you can place a reference marker at the active marker position. A delta marker then displays both the stimulus and response values of the active marker relative to the reference.

Note



The following procedure assumes you have a measurement trace displayed on the network analyzer.

1. Press **MARKER** **All Off** **Marker Search Mkr >Max** to move marker 1 (the active marker) to the maximum value on the trace.
2. Press **Prior Menu** **Marker Functions** **Delta Mkr ON** **Prior Menu** **Marker Search Mkr > Min** to move marker 1 (the active marker ∇) to the minimum point on the trace.

The difference between the markers' frequency and value is shown in the upper-right corner of the network analyzer screen.

You could also move the marker to any other point of interest to determine the difference between the reference marker and the active marker. All subsequent stimulus and response values of the active marker are read out relative to the reference marker. When the amplitude of the measurement trace changes, the reference marker value also changes. The reference marker is shown on the network analyzer screen as a small triangle (delta), smaller than the inactive marker triangles.

Saving and Recalling Measurement Results

The HP 8711A network analyzer allows you to save the following information:

- instrument state settings
- measurement channel data
- measurement calibration information

The instrument state settings consist of all the stimulus and response parameters that set up the network analyzer to make a specific measurement, limit lines, and user-defined cal kit. Instrument state information is saved and recalled for both channels. The measurement channel data consists of the actual measurement data trace. And, the measurement calibration information is the measurement correction data that the network analyzer creates when you make a calibration. You can save any combination of the above three and recall them to be displayed on the network analyzer. You can also dump the measurement channel data to an ASCII format file that you can use for graphing and manipulation in spreadsheets.

You can save your measurement results to the following places:

- internal non-volatile memory
- disk in the internal disk drive
- disk in an external disk drive

Refer to “Appendix C” at the end of Chapter 7, “Reference and Menu Map,” for information on the HP 8711A network analyzer internal non-volatile memory allocation.

To Save a File

Selecting the Disk

1. If you are using a floppy disk, place a formatted disk in the disk drive you are using for data storage. If your disk is not formatted, refer to the procedure in “To Format a Floppy Disk” located later in this section.
2. Press **SAVE/RECALL** **Select Disk** and press the key that corresponds to the disk where you are going to save data.
 - Press **Internal Memory Prior Menu** if you are saving to the network analyzer internal non-volatile memory.
 - Press **Internal Disk Prior Menu** if you are saving to the internal disk drive.
 - Press **Configure Ext. Disk** if you are saving to an external disk drive.
 - If you are configuring the network analyzer for the external disk drive, press the following keys:
 - **Ext. Disk Address** and enter the disk drive address
 - **Ext. Disk Volume** and enter the disk volume number
 - **Ext. Disk Unit** and enter the disk unit number
 - **Prior Menu External Disk Prior Menu**

Defining What You Save

3. Press **Define Save**.
 - Press **Inst State OFF** if you DO NOT want the instrument state saved.
 - Press **Cal ON** if you want to save the active measurement calibration.
 - Press **Data ON** if you want to save the measurement data that is displayed on the network analyzer screen.
4. Press **Prior Menu Save State** to save the instrument state file.

The filename appears on the screen as STATE#.STA (where # is a number). The type of file appears on the screen as BDAT.
5. If you want to dump the data trace to an ASCII format, press **Define Save Save ASCII** and either **Save Chan 1** or **Save Chan 2**, depending on which measurement channel data you want to save.

The filename appears on the network analyzer screen as TRACE#.PRN (where # is a number). The type of file appears as DOS.

Note



DOS files end in .STA or .PRN; file type is DOS. LIF file types are BDAT (binary) or ASCII.

Renaming a File

1. Press **SAVE/RECALL** **Select Disk** and press the key that corresponds to the disk where the desired file is located.
2. Use the front panel knob to move the highlighted bar to the file you want to rename.
3. Press **Prior Menu File Utilities Rename File**.
4. Press **Clear Entry** to erase the current filename from the network analyzer screen.
5. Enter the new filename in one of the following ways:
 - Use an external DIN keyboard connected to the network analyzer rear panel and type in the new filename. (For information on using the DIN keyboard for all network analyzer front panel inputs, refer to “Appendix B” located at the end of Chapter 7, “Reference and Menu Map.”)
 - Use the front panel knob and **Select Character** key to point and select each character of the new filename. Then press **Enter**.

To Recall from a Disk or Internal Memory

The network analyzer allows you to recall and display measurement results that you saved as STATE files. You can then compare the recalled measurements to subsequent measurements.

Calibration sets are linked to the instrument state and measurement parameter for which the calibration was done. Therefore a saved calibration can be used for multiple instrument states as long as the measurement parameter, frequency range, and number of points are the same.

1. Press **SAVE/RECALL** **Select Disk** and press the key that corresponds to the location where your desired file exists.
2. Change the disk directory to the directory that contains the desired file as described in “To Make and Change Directories” in the next section.
3. Press **Prior Menu Prior Menu** and turn the front panel knob to move the highlighted bar to the file you want to recall.
4. Press **Recall State** to recall the desired file to the network analyzer.

To Make and Change Directories

This example shows you how to make directories so you can store files into categories. The procedure also shows you how to change between the various existing directories. You can make directories for floppy disks and the network analyzer internal memory.

With DOS disks, if you “cd” to a subdirectory, remove the disk and press **SAVE RECALL** before inserting the new disk.

Note



Disks formatted in LIF do not support directories.

Making Directories for DOS Disks

1. If you are going to use a floppy disk, place a formatted disk in the drive you are using for data storage. If your disk is not formatted, refer to the procedure in “To Format a Floppy Disk” located later in this section.
2. Press **SAVE/RECALL** **Select Disk**.
3. Choose the location of the disk you want to save the instrument state file to: internal memory, internal disk, or external disk.
4. Press **File Utilities** **Directory Utilities** **Make Directory**.
Think of a logical name to call a directory (not more than 10 characters).
5. Enter the name of the new directory in one of the following ways:
 - Use a DIN keyboard, connected to the network analyzer rear panel, and type in the name of the new directory. (For information on using the DIN keyboard for all network analyzer front panel inputs, refer to “Appendix B” located at the end of Chapter 7, “Reference and Menu Map.”)
 - Turn the front panel knob to the first character of the directory name and press **Select Char**. Continue selecting characters until the complete name appears after **Make Directory =** on the network analyzer screen.
6. Press **Enter** to make a directory with the name you have selected.
7. Press **Make Directory** and repeat steps 4 through 6 to make any other directories you want.

Note



You can also go to a directory and use **Make Directory** to create a subdirectory. The number of characters in a directory and subdirectory path can not exceed 63.

Changing Directories

8. Press the **↑** **↓** keys to highlight the directory you want to change to. Then press **Change Directory**. The current directory name appears in the top box of the displayed table.
9. Highlight **<PARENT>** and press **Change Directory** to return to the disk's parent (main) directory.

If you are in a subdirectory, **<PARENT>** refers to the previous directory, not to the main directory.

To Format a Floppy Disk

You must format unformatted floppy disks before you can save data on them. The network analyzer internal memory does not need to be formatted.

- If you are saving files to recall on an MS-DOS computer, follow the procedure in "Formatting a Disk in the Internal Drive with MS-DOS Format" or "Formatting a Disk in an External Drive with MS-DOS Format," depending on your storage device.
- If you are saving files to recall on an instrument controller that requires LIF formatted disks, follow the procedure in "Initializing a Disk in the Internal Drive with LIF Format."

Formatting a Disk in the Internal Drive with MS-DOS Format

Caution



If the disk you format has been used before, all the previously stored information is erased.

1. Fully close the write protect tab on the disk and place it in the network analyzer disk drive.
2. Press **SAVE/RECALL** **File Utilities** **Format Disk** **Format Int Disk** **Yes**.

Formatting a Disk in an External Drive with MS-DOS Format

Caution



If the disk you format has been used before, all the previously stored information is erased.

1. Fully close the write protect tab on the disk and place it in the disk drive.
2. Disconnect any system controller from the network analyzer.
3. Press **SYSTEM OPTIONS** **HP-IB** **System Controller** to make the HP 8711A network analyzer the HP-IB controller.
4. Press **SAVE/RECALL** **Select Disk** **Configure Ext. Disk**.

5. Press the following keys to configure the network analyzer for an external disk drive:

`Ext. Disk Address` and enter the address (the default is 0)

`Ext. Disk Volume` and enter the disk volume number
(the default is 0)

`Ext. Disk Unit` and enter the disk unit number
(the default is 0)

6. Press `Prior Menu Prior Menu File Utilities`
`Format Disk Format Ext Disk YES`.

Initializing a Disk in the Internal Drive with LIF Format

Caution



If the disk you are initializing has been used before, all the previously stored information is erased.

1. Fully close the write protect tab on the disk and place it in the network analyzer disk drive. Perform steps 2 or 3.
- 2a. Press `(Esc)` on an external keyboard to display an IBASIC command line at the bottom of the screen.
- 2b. Type `INITIALIZE ":INTERNAL"` to begin initialization.
- 2c. Press `(Esc)` to turn off the command line.
- 3a. Press `(SYSTEM OPTIONS) IBASIC Edit Insert Line`.
- 3b. Use the front panel knob and press `Select Char/Word` for each character in the following commands.

`10 INITIALIZE ":INTERNAL,4,1"` (press `Enter`)

`20 END` (press `Enter`)

- 3c. Then press `Prior Menu Prior Menu Run` to initialize the disk.

Printing and Plotting Measurement Results

This section shows you how to create a hardcopy of your measurement results for later analysis. Depending on the choices you make, the hardcopy will appear in one of the various formats shown in Figure 5-3.

The HP 8711A network analyzer allows you to send data to a printer or plotter over the following interfaces:

- HP-IB
- Centronics
- RS-232

You can also plot the displayed measurement results to a file on a disk in the network analyzer internal disk drive.

To Connect the Printer or Plotter to the HP 8711A Network Analyzer

You will only have to do this setup once if you make all your hardcopies with the same printing or plotting device.

1. Connect your printer or plotter to the network analyzer.

The connecting cables for the corresponding types of printers or plotters are listed below.

| Cable | Type | Hardcopy Device |
|-----------|---------------------|-----------------------|
| HP 24542G | Serial-9 pin | Serial Printer |
| HP 24542H | Serial-9 pin | HP 7550A Plotter |
| HP 24542D | Centronics Parallel | Parallel Port Printer |
| HP 10833A | HP-IB | HP-IB Printer/Plotter |

2. Load paper and pen(s) into your printing/plotting device.

To Configure the HP 8711A Network Analyzer Hardcopy Port

You will only have to do this setup once if you make all your hardcopies with the same printing or plotting device. You can configure the HP 8711A network analyzer for any of the peripherals listed below:

| Device | Language | Hardcopy Port |
|------------------|----------|---------------|
| HP PLOTTER | HPGL | PARALLEL PORT |
| HP PLOTTER | HPGL | RS232 SERIAL |
| HP PLOTTER | HPGL | HP-IB |
| HP PRINTER | PCL | PARALLEL PORT |
| HP PRINTER | PCL | RS232 SERIAL |
| HP PRINTER | PCL | HP-IB |
| EPSON COMPATABLE | IBM | RS232 SERIAL |
| EPSON COMPATABLE | IBM | PARALLEL PORT |
| FILE | HPGL | INTERNAL DISK |

The network analyzer allows you to send commands in either HPGL, PCL, or IBM modes. The commands the HP 8711A network analyzer uses are common to early versions of each language. For example, PCL commands that the network analyzer sends will work with PCL3 devices as well as PCL5 devices. The network analyzer also uses commands that are common to IBM mode devices and FX-86e/FX-800 mode Epson compatible devices.

Note



You may notice a decrease in measurement speed when the network analyzer is outputting to a printer or plotter that doesn't have built-in buffers. For the fastest possible hardcopy dump to such devices, press **MENU** **Trigger** **Hold** before beginning the print or plot.

1. Press **HARD COPY** **Select Copy Port** and turn the front panel knob to move the highlighted bar to your printing or plotting device, then press **Select**.

Configuring the HP 8711A Network Analyzer for HP-IB Devices

2. If your printing/plotting device has a different address than the HP 8711A Network Analyzer default of 05, press **Hardcopy Address** and enter the address of your printing/plotting device (factory defaults: printer = 01, plotter = 05).

Configuring the HP 8711A Network Analyzer for RS-232 Devices

3. If the baud rate of your printing/plotting device is different than the default (19200), press **Baud Rate** and enter the baud rate of your printing/plotting device. (Refer to your printer or plotter manual for the baud rate of your device.) You can set the baud rate to 1200, 2400, 4800, 9600, or 19200 baud. If you are sending graphics to the hardcopy device, 9600 or 19200 baud is recommended.
4. Choose between Xon/Xoff (specifies a software handshake) and DTR/DSR (specifies a hardware handshake).

To Define the Hardcopy Device Settings

You will only have to do this setup once if you make all your hardcopies with the same printing or plotting device.

1. Press **HARDCOPY** and then either **Define Printer** or **Define Plotter**, depending on which device you are using.
2. Continue with the procedure in “Defining a Printing Device” if you are using a printer. Otherwise, continue with the procedure in “Defining a Plotting Device.”

Defining a Printing Device

3. Make the following selections in the network analyzer menus:
 - Select the type of printer you have, either monochrome or color.
 - Select the orientation of the paper to the information printed, either portrait or landscape. The portrait choice orientates the printout vertically, the landscape orientates the printout horizontally.
 - If you do NOT want auto feed active, press **Auto Feed** (the default is ON).
 - Press **More Printer** and change any of the following width and resolution defaults:
 - Print Resolution** (the default is 96 dots per inch)
 - Top Margin** (the default is 0 millimeters)
 - Left Margin** (the default is 0 millimeters)
 - Print Width** (the default is 150 millimeters: 6 inches)
- For details on top and left margins and print width, see **Print Width** in Chapter 7, “Reference and Menu Map.”

Use the following table to help specify your print resolutions.

| Printer | Resolutions |
|----------|-------------------|
| ThinkJet | 96 |
| QuietJet | 96, 192 |
| DeskJet | 75, 100, 150, 300 |
| PaintJet | 90, 180 |
| LaserJet | 75, 100, 150, 300 |
| Epson | 60, 120, 240, 360 |

4. Continue with the procedure in “To Define the Hardcopy Output.”

Defining a Plotting Device

5. Make the following selections in the network analyzer menus:
 - Select the type of plotter you have, either a monochrome or color.
 - Press **Set Pen Numbers** and select the pen number(s) for the data traces, memory traces, graticule, and graphics. Then press **Prior Menu**.
 - If you do NOT want auto feed active, press **Auto Feed** (the default is ON).
6. Continue with the procedure in “To Define the Hardcopy Output.”

Restoring the Hardcopy Device Defaults

You can restore default printing and plotting settings by pressing **Restore Defaults** in menus under the **HARDCOPY** key. The defaults that you can set under each menu are listed below.

| Menu Name: Softkey | Default Settings |
|--------------------|---|
| Select Copy Port | Copy Device = HP Printer, Parallel port Baud Rate = 19200, Handshake = Xon/Xoff Hardcopy Address = 05 |
| Define Printer | Monochrome, Portrait, Autofeed ON |
| Define Plotter | Monochrome, Autofeed ON |
| Define Hardcopy | Graph and Marker Table |
| Define Graph | Trace Data ON, Graticule ON, Title+Clock ON Annotation ON, Marker Symbol ON |
| More Printer | Printer Resolution = 96 Print Width = 200 mm (7.87 inches) Left Margin = 0.0, Top Margin = 0.0 |
| Set Pen Number | Trace 1 = Pen 1 Trace 2 = Pen 2 Memory 1 = Pen 3 Memory 2 = Pen 4 Graticule = Pen 5 Graphics = Pen 6 |

This section shows how to define the portions of the screen to be printed or plotted.

To Define the Hardcopy Output

1. If you have an external controller connected to the network analyzer, press **SYSTEM OPTIONS** **HP-IB System Controller** to make the network analyzer control the peripherals.
2. Press **HARD COPY** **Define Hardcopy**.
3. Select the portions of the displayed measurement you want to appear on your hardcopy. Refer to Figure 5-3 to see the available hardcopy components and formats.
 - If you want both the graph and marker table to appear on the hardcopy press **Graph and Mkr Table**.
 - If you only want the graph to appear on the hardcopy press **Graph Only**. (You can also print limit-line tables in this mode.)
 - If you only want the marker table to appear on the hardcopy, press **Mkr Table Only**. (You can also print limit-line tables in this mode.)

- If you are printing a hardcopy and you want a list of the data trace values, press **List Trace Values**. (“List Trace Values” is only available for a hardcopy generated on a printer.)

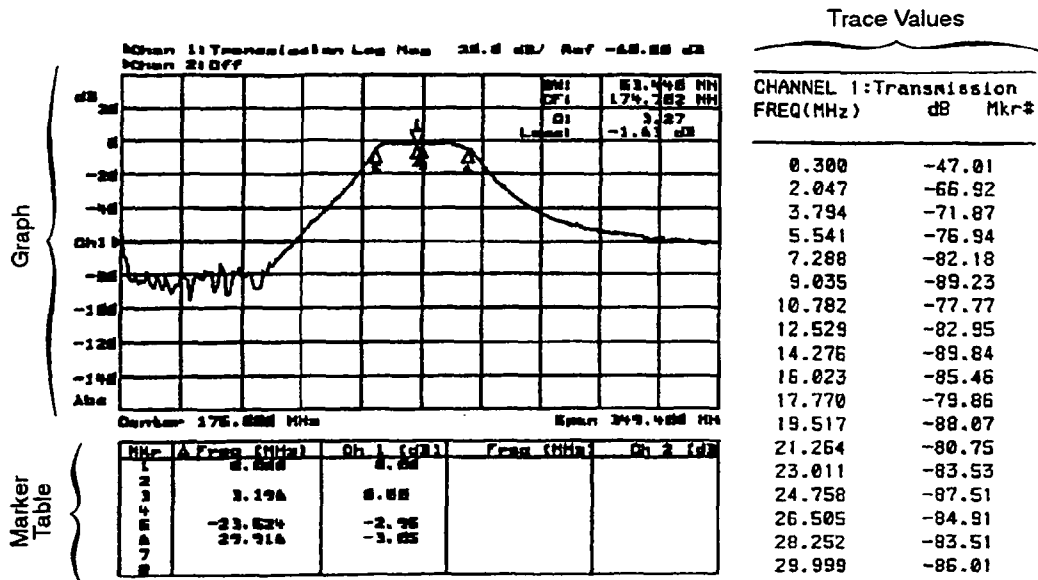

Figure 5-3. Hardcopy Components and Formats Available

4. Press **Define Graph**.
5. Select the portion(s) of the graph that you do NOT want to appear on your hard copy. Refer to Figure 5-4 to see the various components of the graph.
 - If you do NOT want the measurement trace data to appear on your hard copy press **Trace Data** (the default is ON).
 - If you do NOT want the graticule to appear on your hardcopy, press **Graticule** (the default is ON).
 - If you do NOT want the annotation (text) of the measurement to appear on your hardcopy, press **Annotation** (the default is ON).
 - If you do NOT want the markers to appear on your hardcopy, press **Mkr Symbol** (the default is ON).
 - If you do NOT want the title and clock (time) of the measurement to appear on your hardcopy, press **Title + Clk** (the default in ON).

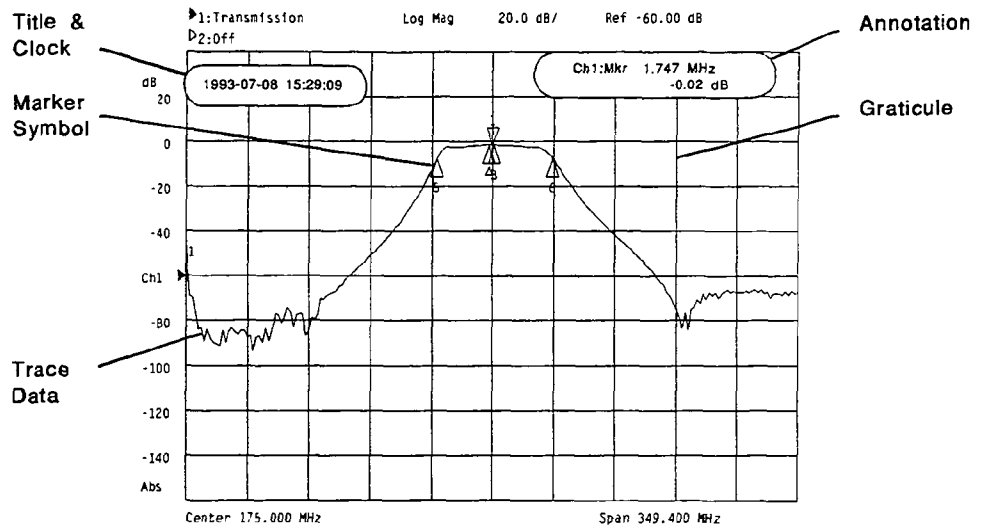

Figure 5-4. Graph Components Available

To Title Displayed Measurement Results

1. Press **DISPLAY** More Display Title and Clock Enter Line 1.
2. Create the title in one of the following ways:
 - Connect an external DIN keyboard to the network analyzer rear panel and type in the title for your measurement. (For information on using the DIN keyboard for all network analyzer front panel inputs refer to "Appendix C" located at the end of Chapter 7, "Reference and Menu Map.")
 - Turn the front panel knob and press **Select Char** for each character. When the title is complete, press **Enter**.
3. If you want to make a two-line title, press **Enter Line 2** and repeat the previous step.

To Generate a Hardcopy Output

1. If your hardcopy device is connected to an HP-IB port, press **SYSTEM OPTIONS** HP-IB System Controller to make the network analyzer the system controller.
2. If you defined your hardcopy to be "Graph and Mkr Table" or "Graph Only" and you ran a limit test, you can print the limit-line tables by pressing **DISPLAY** Limit Line.
3. Press **HARDCOPY** Start.

During the hardcopy generation, you can change any HP 8711A network analyzer settings, except the settings that are being used for the print or plot.

To Save a Plot File to Disk

Instead of sending a displayed measurement result to a plotter or printer for a hardcopy output (described earlier in this section), you can save it as a file to a disk in the network analyzer internal disk drive. The following procedure shows you how to plot to a file.

1. Place a formatted disk in the network analyzer disk drive. If your disk is not formatted, refer to the procedure in “To Format a Floppy Disk” located earlier in this chapter.
2. Press **HARDCOPY** **Select Copy Port**.
3. Turn the front panel knob to move the highlighted bar down to the entry that reads FILE-HPGL-Internal Disk.
4. Press **Select Prior Menu Start** to send the displayed measurement results to the disk.

The file is saved with a filename of PLOT# (where # is a number).

5. If you want to rename the file refer to the procedure in “Renaming a File” located earlier in this chapter.

Limit Testing

When you switch limit testing on, the network analyzer compares a test device response to specified test limits that you create. You can set the limits in two ways:

- limit lines
- limit points

A limit line is displayed between two sets of values that designate the beginning and ending of the limit line. For each set of values you designate a frequency and an amplitude level. You also designate whether each limit line is for a maximum or minimum test limit.

A limit point is displayed at a specified frequency and amplitude level point that you choose. You must also specify if the point is a maximum or minimum test limit. When you use a limit point for limit testing, the limit is applied at the measurement frequency closest to the limit point frequency. In other words, the limit point frequency is shifted to the closest measurement point frequency. In certain cases, this shift may cause measurements which appear to exceed the limit to pass. If this is a problem, change either the measurement point or limit point frequencies to match.

The network analyzer then detects if a test device performs within the limits you've set and shows pass/fail results. Figure 5-5 shows an example of a limit test.

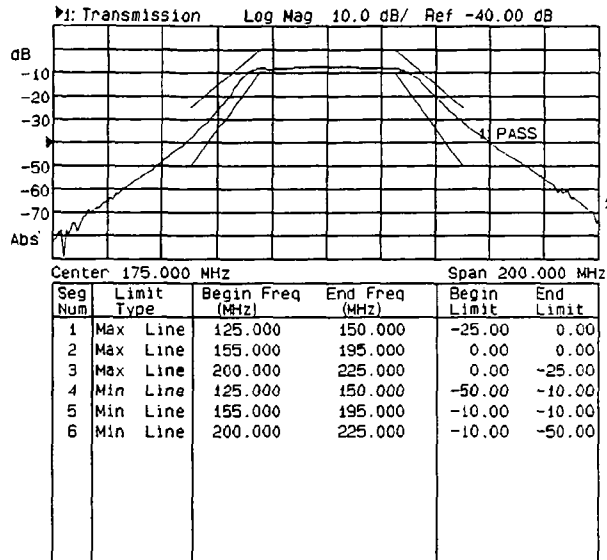

Figure 5-5. Example of a Limit Test

To Create a Limit Test

In this example you set up a limit test for an RF filter.

Note



This procedure assumes a device response is displayed on the network analyzer screen.

Setting Up the Measurement

1. Connect the filter between the network analyzer's RF OUT and RF IN ports.
2. Press **PRESET** **FREQ** **Center** and enter the center frequency of your RF filter.

In this example, the center frequency is 175 MHz.

3. Press **Span** and enter the frequency span that will make it easy to view the passband of your filter.

In this example, the frequency span is 200 MHz.

4. Press **SCALE** **Autoscale** to view the entire measurement trace.

Setting up the Limit Test

5. Press **DISPLAY** **Limit Line**.

The network analyzer screen is split to display the limit-line placement around the measurement trace and the list of limit-line values.

6. Press **Add Limit**.

Defining the Maximum Limit Lines

7. Press **Add Max Line** to set up a limit line that is above the desired device response.
8. Press the softkey labeled **Marker** and turn the front panel knob to locate the frequencies where you want to place the beginning and end of each limit line. Record each frequency for later reference.

To enter limit lines by eye (without keying in frequencies or amplitudes), set the frequencies and amplitude with the knob. You can watch the limit line move as you change its parameters.

In this example the response of the filter is measured against three maximum limit lines:

- the low side of the cutoff frequency portion (125 to 150 MHz)
- the bandpass portion (155 to 195 MHz)
- the high-side of the cutoff frequency portion (200 to 225 MHz)

9. Press **Begin Frequency** and enter the beginning frequency of the first maximum limit line (125 MHz).

Note



If you make a mistake when entering the value, you can back space over it if you have not yet pressed **MHz**. If you see the mistake after pressing **MHz**, press **Begin Frequency** again and enter the correct value.

10. Press **End Frequency** and enter the ending frequency of the first maximum limit line (150 MHz).

A limit line is visible at zero (0.0) unit level in between the frequencies you've designated.

11. Press **Begin Limit** and turn the front panel knob while viewing the measurement trace. Place the beginning of the limit line at the device's maximum allowable output power level for the beginning frequency. (For this example the limit is set to -25.)

The table displayed in the bottom of the network analyzer screen shows you the frequencies and limits you've set.

12. Press **End Limit** and turn the front panel knob while viewing the measurement trace. Place the end of the limit line at the device's maximum allowable output power level for the ending frequency. (In this example the limit left at 0.)

You can iterate between setting the beginning and ending of the limit line. The bottom half of the network analyzer screen has the listing of the first maximum limit line.

13. Press **Prior Menu Add Max Line** and repeat steps 8 through 12 for the frequencies of the second and third maximum limit lines (for this example: 155 to 195 MHz and 200 to 225 MHz).

Defining Minimum Limit Lines

14. Press **Prior Menu Add Min Line** to set up a limit line that is below the desired device response.
15. If you want the minimum limit lines to be placed at different frequencies than the maximum limit lines, press the softkey labeled **Marker** and turn the front panel knob to locate the frequencies where you want to place the beginning and end of each limit line. Record each frequency for later reference.

For this example, the frequencies used for the maximum and minimum limit lines are slightly different:
 - the low side of the cutoff frequency portion (125 to 150 MHz),
 - the bandpass portion (155 to 195 MHz)
 - the high-side of the cutoff frequency portion (200 to 225 MHz)
16. Press **Begin Frequency** and enter the beginning frequency of the first minimum limit line (125 MHz).

Note



If you make a mistake when entering the value, you can back space over it if you have not yet pressed **MHz**. If you see the mistake after pressing **MHz**, press **Begin Frequency** again and enter the correct value.

17. Press **End Frequency** and enter the ending frequency of the first minimum limit line (150 MHz).

A limit line is visible in between the frequencies you designated at zero (0.0) unit level.

18. Press **Begin Limit** and turn the front panel knob while viewing the measurement trace. Place the beginning of the limit line at the device's minimum allowable output power level for the beginning frequency. (In this example the limit is set to -50.)
19. Press **End Limit** and turn the front panel knob while viewing the measurement trace. Place the end of the limit line at the device's minimum allowable output power level for the ending frequency. (In this example the limit is set to -10.)

The bottom half of the network analyzer screen has the listing of the first minimum limit line.

20. Press **Prior Menu Add Min Line** and repeat steps 15 through 19 for the frequencies of the second and third minimum limit lines (for this example: 155 to 195 MHz and 200 to 225 MHz).

For a hardcopy of the limit table, press **HARDCOPY Start** when the marker limit table is on screen.

To Determine if a Measurement Is Out-of-Limits

1. Press **DISPLAY** **Limit Line** **Limit Test ON**.

An out-of-limit test condition is normally indicated in four ways:

- a FAIL message on the network analyzer screen
- a FAIL on the hardcopy listing of limits set
- an HP-IB event status report
- a rear panel TTL limit output

Note



To help simplify the displayed measurement, turn the graticule OFF after you have set up the limits. Press **DISPLAY** **More Display** **Graticule OFF**.

To Edit Limits

You can edit any individual frequency, limit, or limit line after you've created it.

1. Press **DISPLAY** **Limit Line**.

The network analyzer screen is split between the test device response with limit lines and the tabular listing of the limits set. The highlighted bar across the list of limits indicates the selected parameters for editing.

2. Press the arrow keys (**↑** **↓**) to move the highlighted bar to the portion of the test parameter you want to edit.
3. Press **Edit Limit**.
4. Press the keys that correspond to the portions of the limit you want to edit (begin frequency, end frequency, begin limit, end limit). Enter the new values with the keypad or marker.
5. Press **Prior Menu** to return to the limit-line menu.
6. Press **Limit Test ON** to activate the limit test with the new limit line(s).

The PASS/FAIL results of the limit test are displayed on the network analyzer screen.

Displaying Measurement Traces

You can save each channel's measurement data into the network analyzer's trace memory. When using this feature, you can compare two measurements by displaying both the data and memory trace.

You can view measurement traces simultaneously in the following ways:

- display both measurement channel 1 and measurement channel 2
- display a memory trace and a current measurement trace
- combine the two previously listed functions

The network analyzer has two available memory traces, one per channel. When you save the instrument state using the **SAVE/RECALL** key, the trace currently in trace memory is also saved. Since the two measurement channels are independent, you can only recall the memory trace from the channel where you saved the trace.

A recalled measurement trace must have the same number of points as the current measurement for the network analyzer to display both traces (recalled and current).

Note



The following procedure assumes you have a measurement trace displayed on the network analyzer.

To Display Measurements at Different Power Levels

This example procedure shows a measurement of an RF amplifier.

1. Press **DISPLAY** **Data->Memory**.

This stores the measurement data in the memory of the active channel (currently channel 1).

2. Press **Data and Memory**.

The network analyzer displays the stored measurement data and current measurement data simultaneously. It also indicates what it's displaying with a &M at the top line of the screen.

3. Press **POWER** **Level** and either use the front panel knob or the **↑** **↓** to vary the test device input power.

Figure 5-6 shows the amplifier response to 0 dBm and the current measurement response to 12 dBm.

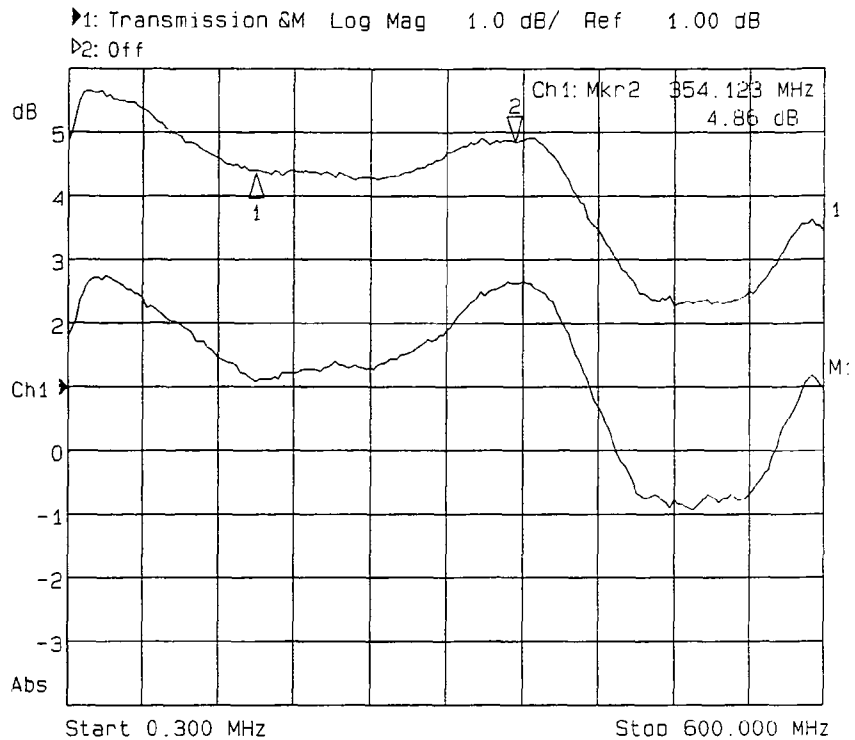

Figure 5-6.
Displaying Two Measurements Made at Different Power Levels

To Display Different Characteristic Measurements

You may find it useful to view more than one measured characteristic parameter at a time. For example, viewing simultaneous insertion loss and return loss measurements are useful when adjusting a device for maximum power transfer.

Note



The following procedure assumes you have a measurement trace displayed on the network analyzer.

This example procedure is written for measuring the bandpass filter that was shipped with your network analyzer.

1. Press **PRESET** **CHAN 1** **Transmission** to measure the insertion loss of the filter.
2. Press **FREQ** **Center** and enter the center frequency of your filter. (In this example the center frequency is 175 MHz.)
3. Press **CHAN 2** **Reflection** to measure the return loss of the filter.

4. Press **DISPLAY** **More Display** **Split Disp** to setup a screen for viewing both measurement channels with the two traces overlaid.
 - Press **Split** if you want to view the two measurement channels on separate graticules.

The measurement parameters for the two measurement channels are also annotated separately.

Figure 5-7 shows the difference between full and split screen displays when viewing both a return loss and insertion loss measurement.

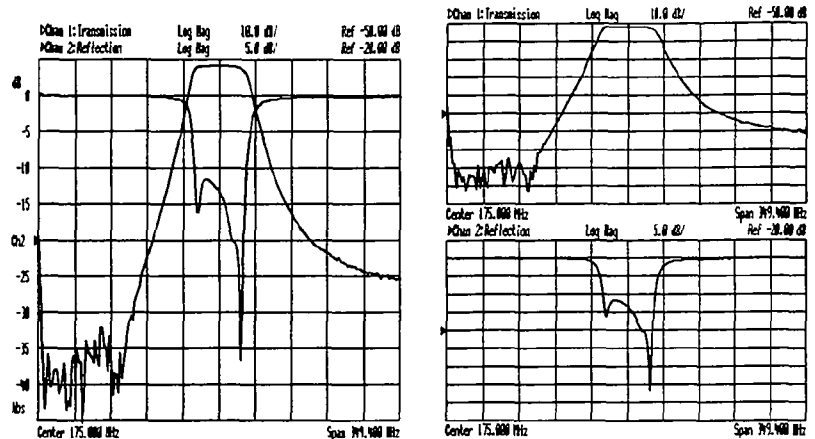

Figure 5-7. Example of Full and Split Screen Displays

5. Press **SWEEP** **Alt Sweep ON** to sweep channel 1 and channel 2 alternately. This allows you to “uncouple” the two channels from each other. By uncoupling the channels, the network analyzer allows you to set different measurement parameters on each channel, such as:
 - frequencies
 - sweep time
 - averaging

Viewing the Ratio of Two Measurement Traces

The network analyzer allows you to view the ratio of two measurements by normalizing the data to the memory, and then displaying the result. This is useful in measurements of gain or attenuation.

Note



The following procedure assumes you have a measurement trace displayed on the network analyzer.

This example shows the gain variance of an RF amplifier when you change the input power.

1. Press **PRESET** **DISPLAY** **Normalize**.

This stores the current active measurement data in the memory of the active channel and displays the data divided by memory.

2. To change the test device input power, press **POWER** **Level** **10** **ENTER**.

Figure 5-8 shows the gain difference between two input power levels.

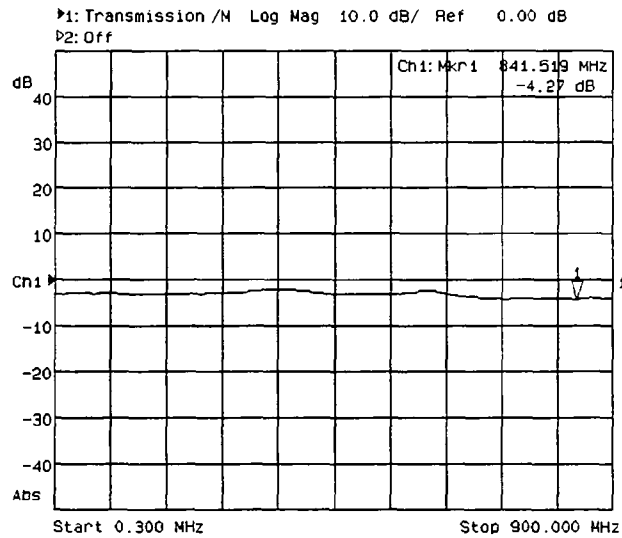

Figure 5-8. Gain Difference between Two Measured Power Levels

Optimizing Measurements

This chapter describes techniques and network analyzer functions that help you achieve the best measurement results. The following sections are included in this chapter.

| | |
|--|------|
| Increasing Sweep Speed | 6-2 |
| To Increase the Start Frequency | 6-2 |
| To Set the Sweep Time to AUTO Mode | 6-2 |
| To Widen the System Bandwidth | 6-2 |
| To Reduce the Amount of Averaging | 6-2 |
| To Reduce the Number of Measurement Points | 6-3 |
| To View a Single Measurement Channel | 6-3 |
| To Turn Off Alternate Sweep | 6-3 |
| To Turn Off Spur Avoidance | 6-3 |
| Increasing Dynamic Range | 6-4 |
| To Increase the Receiver Input Power | 6-4 |
| To Reduce the Receiver Noise Floor | 6-4 |
| Reducing Trace Noise | 6-5 |
| To Activate Averaging for Reducing Trace Noise | 6-5 |
| To Change System Bandwidth for Reducing Trace Noise | 6-5 |
| To Eliminate Receiver Spurious Responses | 6-6 |
| Increasing Measurement Accuracy (Measurement Cals) | 6-7 |
| To Determine if a Measurement Calibration Is Necessary ... | 6-7 |
| To Calibrate for a Transmission Measurement | 6-10 |
| To Calibrate for a Reflection Measurement | 6-11 |
| To Calibrate for a Power or Conversion Loss Measurement . | 6-12 |
| To Calibrate with a User-Defined Cal Kit | 6-13 |
| How to Download Standards | 6-13 |
| To Save the Measurement Calibration | 6-14 |

Increasing Sweep Speed

You can increase the network analyzer sweep speed by avoiding the use of some features that require computational time for implementation and updating. For example, bandwidth marker tracking.

You can also increase the sweep speed by making adjustments to the measurement settings. Listed below are general rules for experimenting with increasing sweep speed.

- increase the start frequency
- sweep in AUTO mode
- widen the system bandwidth
- reduce the amount of averaging
- reduce the number of measurement points
- only view a single channel
- turn off alternate sweep
- turn off spur avoidance

To Increase the Start Frequency

Since the HP 8711 network analyzer sweeps the low frequencies at a slower rate, you can increase the start frequency to speed up the sweep.

1. Press **FREQ** **Start**.
2. Enter a frequency between 5 and 25 MHz.

To Set the Sweep Time to AUTO Mode

Auto sweep time mode (the preset instrument mode), maintains the fastest sweep speed possible for any particular measurement settings.

1. Press **SWEEP** and look at the **Sweep Time/AUTO man** softkey label.
2. If necessary, press **Sweep Time/auto MAN** to toggle the time mode to AUTO.

To Widen the System Bandwidth

Wide system bandwidth is recommended for broadband detection measurements.

Press **AVG** **System Bandwidth Wide** to widen the IF bandwidth.

To Reduce the Amount of Averaging

By reducing the amount of averaging (or turning it off: preset mode) you can increase the network analyzer's measurement speed. Averaging requires multiple sweeps which increases measurement time. Turning off averaging and using a smaller system bandwidth may produce faster results.

1. Press **AVG** **Avg Factor** and enter an averaging factor that is less than the value displayed on the network analyzer screen and press **ENTER**.
2. If you want to turn the averaging off, press **AVG** **Averaging OFF**.

To Reduce the Number of Measurement Points

Sweep time changes with the number of points, as indicated in the table below.

Sweep Time versus Number of Points

| Number of Points | Relative Sweep Time |
|------------------|---------------------|
| 51 | 0.8 |
| 101 | 0.9 |
| 201 | 1.0 |
| 401 | 1.3 |
| 801 | 1.6 |
| 1601 | 2.6 |

Press **MENU** **Number of Points** and enter the reduced number.

To View a Single Measurement Channel

1. Press **CHAN 1** **Chan OFF** so the measurement on channel 1 is not displayed.
2. Press **CHAN 2** to view the measurement on channel 2 only.
3. Alternately, press **Chan OFF** **CHAN 1** and then **Chan OFF** **CHAN 2** to observe different characteristic parameters measured on two channels (instead of using dual channel mode).

To Turn Off Alternate Sweep

The alternate sweep is automatically activated with some dual channel measurements. The alternate sweep feature sweeps and measures one channel at a time. By disengaging this feature, you increase the sweep speed by 50 percent.

1. Press **SWEEP** and look at the **Alt Sweep** softkey.
2. Toggle the softkey to disengage the alternate sweep feature (the softkey should appear **Alt Sweep on/OFF**).

To Turn Off Spur Avoidance

When spur avoidance is on (preset default is off), the network analyzer breaks each sweep into segments. Between sweep segments, the network analyzer stops and changes internal frequencies to move mixing products. Since the network analyzer sweep is not interrupted when this feature is off, turn off spur avoidance to increase sweep speed.

1. Press **MENU** **Spur Avoid** and look at the **Spur Avoid** softkey.
2. Toggle the softkey to disengage the spur avoidance feature (the softkey should appear **Spur Avoid on/OFF**).

Increasing Dynamic Range

Dynamic range is the difference between the network analyzer's maximum allowable input level and its broadband noise floor. For a measurement to be valid, input signals must be within these boundaries. The dynamic range is affected by three factors:

- receiver input power
- receiver noise floor
- receiver spurious response

To Increase the Receiver Input Power

You should maximize the receiver input power to achieve the highest dynamic range. You can increase the network analyzer's source output power so that the test device output power is within the measurement range of the network analyzer.

Press **POWER** **Level** and **(↑)** and enter the new source power level.

If your test device output power stays within the maximum input limits, shown below, the receiver will not go into compression.

Maximum Recommended Input Power Levels

| | Maximum Input Level |
|-----------------|---------------------|
| Narrowband Mode | +10 dBm |
| Broadband Mode | +16 dBm |

Caution



RECEIVER INPUT DAMAGE LEVEL: +20 dBm

To Reduce the Receiver Noise Floor

Since the dynamic range is the difference between the network analyzer's input level and its noise floor, using the following techniques to lower the noise floor will increase the network analyzer's dynamic range.

Changing System Bandwidth

In narrowband measurements, each tenfold reduction in system bandwidth lowers the noise floor.

1. Press **AVG** **System Bandwidth**.
2. Press the key that corresponds to the bandwidth you want.
 - **Wide** sets the bandwidth to 6500 Hz.
 - **Medium** sets the bandwidth to 750 Hz.
 - **Narrow** sets the bandwidth to 250 Hz.

Wide system bandwidth is recommended for broadband detection measurements only.

Changing Measurement Averaging

You can apply exponential averaging of successive measurement traces to remove the effects of random noise. Increasing the number of averages (averaging factor) lowers the noise floor.

1. Press **AVG** **Average Factor**.
2. Enter a value followed by **ENTER**.
3. Press **Average ON off**.

Averaging is explained more fully under “Noise Reduction” in Chapter 8, “How the Analyzer Works.”

Reducing Trace Noise

You can use three network analyzer functions to help reduce the effect of noise on the data trace:

- activate measurement averaging
- reduce system bandwidth
- eliminate spurious responses

To Activate Averaging for Reducing Trace Noise

The network analyzer uses a weighted running average for IF averaging. The noise is reduced with each new sweep as the effective averaging factor increments.

1. Press **AVG** **Average Factor**.
2. Enter a value followed by **ENTER**.
3. Press **Average ON off**.

Averaging is explained more fully under “Noise Reduction” in Chapter 8, “How the Analyzer Works.”

To Change System Bandwidth for Reducing Trace Noise

By reducing the system bandwidth you reduce the noise that is measured during the sweep. However, the bandwidth may slow down the sweep. While averaging requires multiple sweeps to reduce noise, narrowing the system bandwidth reduces the noise on each sweep.

Press **AVG** **System Bandwidth Narrow**.

Narrower system bandwidths cause longer sweep times. When in auto sweep time mode, the network analyzer uses the fastest sweep time possible for any selected system bandwidth. Auto sweep time mode is the default network analyzer setting.

To Eliminate Receiver Spurious Responses

The network analyzer has two features to eliminate spurious responses. Both features shift the frequency of the spur without changing the RF output frequency. They shift the spur by changing frequencies internal to the network analyzer that mix to produce the RF frequency. The features are:

- spur avoid
- dither

Dither is recommended for narrow frequency span measurements as explained below. If dither does not eliminate visible spurs, use spur avoid instead.

Dithering to Shift Spurs

Dither shifts all spurs by a small amount once, thus it imposes no sweep time penalty. But some spurs occurring within the measured frequency band may not be shifted out of band, and others may be shifted in. Therefore dither is most effective for narrowband measurements with a user defined measurement calibration. To use the dither feature,

1. Press **MENU** **Spur Avoid** **Dither ON/off**.
2. Make a user-defined measurement calibration. Refer to the “Calibrating for Measurements” section located earlier in this chapter for calibration procedures.

You will invalidate the measurement calibration if you turn dither off.

Activating Spur Avoidance

When you activate spur avoidance the network analyzer sweeps to a point before a spur, stops the sweep, shifts the spur, sweeps through the spur location, then shifts the spur back and continues the sweep. The network analyzer determines which spurs need to be avoided with an algorithm based on frequencies, number of points, sweep time, and system bandwidth.

1. Follow the steps in the “Dithering to Shift Spurs” procedure.
2. Press **MENU** **Spur Avoid** **Spur Avoid ON/off**.

**Increasing
Measurement
Accuracy
(Measurement Cals)**

This section shows you how to determine if your measurement system requires a user-defined calibration. Instructions are also included for making the different types of measurement calibrations that are available for the HP 8711 network analyzer. Information that explains how a measurement calibration increases measurement accuracy is located in Chapter 8, "How the Analyzer Works."

**To Determine if a
Measurement
Calibration Is
Necessary**

If all of the following conditions are met, the network analyzer can provide highly accurate measurements without performing any additional calibration.

Conditions Where a Calibration Is NOT Necessary

- Your test device is connected directly to the reflection port with no adapters or intervening cables.
- Your test device is nominally a 50 Ω device for a standard network analyzer or a 75 Ω device for a 75 Ω option network analyzer.
- The default instrument state is used:
 - 300 kHz to 1.3 GHz
 - 0 dBm output power
 - medium bandwidth

If your test setup meets these conditions, you do not need to proceed any further in this section.

Conditions Where a Calibration IS Necessary

- You are adapting to a different connector type or impedance.
- You are connecting a cable between the test device and the network analyzer test ports.
- You are measuring a narrowband or electrically long device.
- You are connecting any attenuator or other such device on the input or output of the test device.

When your test setup meets the conditions above, several system parameters are affected:

- characteristics at device input
- amplitude at device input
- frequency response accuracy
- directivity
- source match

The network analyzer has several methods of measuring and compensating for these test system errors. Each method removes one or more of the systematic errors using an equation called an error model. Measurement of high quality standards (short, open, load, through) allows the network analyzer to solve for the error terms in the error model. The accuracy of the calibrated measurements is dependent on the quality of the standards used for calibrating. Since calibration standards are very precise, great accuracy is achieved. Information that explains how the calibration increases measurement accuracy is located in Chapter 8, "How the Analyzer Works."

Measurement Calibration Methods Available

- normalization
- transmission
- reflection

Normalization is the simplest type of calibration. This calibration does not use an error correction array. The network analyzer stores data into memory and divides subsequent measurements by the

stored data to remove frequency response errors. This is the only type of calibration available for both narrowband and broadband measurements.

Transmission calibrations measure narrowband response to correct for frequency response tracking errors. This type of calibration is for narrowband measurements only.

Reflection calibrations measure directivity, source match, and tracking to correct for directivity, source match and frequency response errors. This type of calibration is also for narrowband measurements only.

Transmission and Reflection Calibrations Available

- restore defaults
- full band
- user-defined

The three calibration types vary in performance method, frequency span, and number of points. Data can be interpolated between points for reduced spans, but not extrapolated.

Restore Defaults calibrations recall error correction arrays that the network analyzer previously generated by an adjustment test and stored in memory. This calibration is full band (entire frequency span) and uses 801 frequency points. It is quick and convenient but not as accurate at narrow spans. This calibration is also known as the default or internal calibration.

Full Band calibrations use error correction arrays generated by the user at the time of calibration. Full band calibrations use 801 frequency points and narrow system bandwidth. They can correct for the effects of test setup attenuators, amplifiers, switches, cabling, etc. After calibration, you can reduce the frequency span. Interpolation recalculates the error correction array for reduced spans, so some accuracy is sacrificed for convenience.

User-Defined calibrations, or user-calibrations, also use error correction arrays generated by the user at the time of calibration. But first you must set the frequency span and then not widen it after the calibration (you can narrow it). Because this calibration uses the frequency span and number of points of choice (up to 1601), it is potentially the most accurate calibration. It is recommended for narrow frequency spans.

When this cal is on, the network analyzer displays a **C** at the top of the screen.

To Calibrate for a Transmission Measurement

1. Press **PRESET** **CHAN 1** **Transmissn**.
2. Set measurement parameters that are particular to the measurement you are going to make:
 - power level
 - number of points
 - sweep time
 - system bandwidth
 - frequencies
3. Connect the equipment as shown in Figure 6-1.

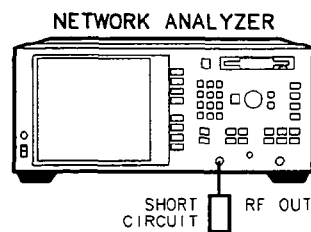

ad524a

Figure 6-1. Connections for a Transmission Measurement Calibration

4. Press **CAL** **Transmissn** and select the type of calibration you want based on the above measurement settings.
 - If you select **Restore Defaults** the network analyzer restores the factory calibration that was made at 801 data points across the entire frequency range and interpolated.
 - If you select **Full Band** the network analyzer sets up 801 data points across the entire measurement band (0.3 to 1300 MHz).
 - If you select **User Defined** the network analyzer sets up the data points you set evenly spaced over the frequency range that you specify (define). This calibration is more accurate, taken at the exact frequencies, power level, system bandwidth, etc. that you specify. But if you change frequencies, power, or sweep time, the measurement accuracy is reduced.
5. When the prompt appears on the network analyzer screen, press **Measure Standard**.

Wait for the network analyzer to measure the standard and calculate the calibration coefficients. A message is displayed on the network analyzer when the calibration is complete.
6. If you want to save the measurement calibration, follow the procedure in “To Save the Measurement Calibration” later in this section.

To Calibrate for a Reflection Measurement

1. Press **PRESET** **CHAN 1** **Reflection**.
2. Set measurement parameters that are particular to the measurement you are going to make:
 - power level
 - number of points
 - sweep time
 - system bandwidth
 - frequencies
3. Press **CAL** **Reflection** and select the type of calibration you want.
 - If you select **Restore Defaults** the network analyzer restores the factory calibration that was made at 801 data points across the entire frequency range and interpolated.
 - If you select **Full Band** the network analyzer sets up 801 data points across the entire measurement band (0.3 to 1300 MHz).
 - If you select **User Defined** the network analyzer sets up the data points you set evenly space over the frequency range that you specify (define). As in the transmission cal, this calibration is more accurate, taken at the exact frequencies that you specify. But if you change frequencies, power, or sweep time, the measurement accuracy is reduced.
4. When prompted on the network analyzer screen, connect an open, a short, and then a load as shown in Figure 6-2. Press **Measure Standard** after each connection.

A message is displayed when the calibration is complete.
5. If you want to save the measurement calibration, follow the procedure in “To Save the Measurement Calibration” later in this section.

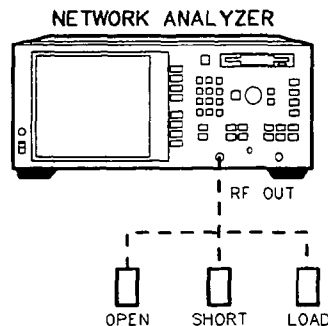

ad625a

Figure 6-2. Connections for a Reflection Measurement Calibration

To Calibrate for a Power or Conversion Loss Measurement

1. Connect all the equipment as you would for making a power or conversion loss measurement, except substitute a through cable in place of your test device. If you will be using filters in mixer measurements or a preamplifier and an attenuator in your measurement setup, be sure to include them in the calibration as shown in Figure 6-3.

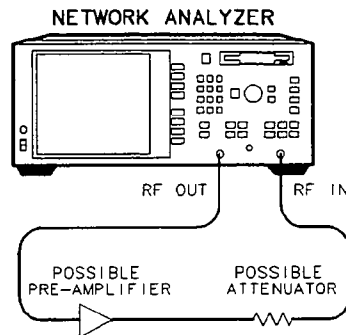

ad629a

Figure 6-3. Connections for a Power or Conversion Loss Measurement Calibration

2. Press **PRESET** **CHAN 1** and select the type of measurement you want to make.
 - Press **Power** if you want to measure the test device output power nonratioed to the device input power. This measurement is when the RF drive is < -20 dBm.
 - Press **Conversion Loss** if you want to measure the test device output power ratioed to the device input power. This measurement is when the RF drive is > -20 dBm.
3. Set measurement parameters that are particular to the measurement you are going to make:
 - power level
 - number of points
 - sweep time
 - system bandwidth
 - frequencies

Caution



You can damage the HP 8711 network analyzer by measuring an input > 20 dBm. Insert an attenuator in the measurement setup if necessary.

4. Press **CAL** **Normalize**.
5. If you want to save the measurement calibration, follow the procedure in "To Save the Measurement Calibration" later in this section.

To Calibrate with a User-Defined Cal Kit

To make a measurement calibration for a connector type that is not stored in the network analyzer, you must enter definitions for that type. The network analyzer is supplied with cal kit definitions for these connector types: type-N male and female and 3.5 mm.

For other connector types, the easy way to enter definitions is to download them from a disk where the definitions are stored in the format of a BASIC program. Another way is to use the template program on the Example Programs disk as a starting point.

How to Download Standards

1. Insert disk with cal standard definitions in internal disk drive.
2. Press **SAVE RECALL** and note the first word of the second line on the screen. If it is not "INT:\", (for internal disk), press **Select Disk Internal Disk SAVE RECALL**
3. Highlight the file (CALKIT, in the case of the Example Programs disk).
 - a. Press **Recall State** and wait for the prompt:
Loaded cal kit information for 4 calibration standards
Recall of cal kit from CALKIT complete
4. Press **CAL Cal Kit User Defined**.

Note



Cal kit coefficients are displayed in the cal kit block of the operating parameters screen; press **SYSTEM OPTIONS Operating Parameters Next Screen**.

5. Set up the measurement as desired.
6. Press **CAL** and select the desired type of cal (transmission or reflection).
7. Select **Full Band** or **User Defined** to begin the measurement calibration.
8. Follow the prompts to complete the calibration.

Cal Kit File Notes

If you want to write your own cal kit definition program or edit standard definitions, keep these factors in mind:

- First line of file must begin with:
 - Line number (10, for example)
 - Exclamation point (!)
 - Dollar sign (\$)
- Information must be in DOS or LIF ASCII file format
- Maximum number of characters: 1700
- Maximum number of lines: 99

- Maximum number of characters per line: 79
- Typical size of cal kit definition: about 600 bytes
- Recognized standard types and number of coefficients:
 - Open 7
 - Short 3
 - Load 3
 - Thru 3
- Recognized coefficients by name and where used:
 - Z0 (letter Z, number 0), all
 - Delay, all
 - Loss, all
 - C0 (letter C, number 0), open only
 - C1, open only
 - C2, open only
 - C3, open only
- No explicit title, header, or file extension required.
- No restrictions on capitalization or white space.

Note



Downloaded and selected user-defined kits are part of the instrument state and can be saved in the save-recall registers or to disk.

How To Edit Cal Kit Files

The file is a DOS or LIF ASCII file in the format of a BASIC program. It can be edited with a computer or the internal IBASIC editor. Keep in mind the above factors. For details on IBASIC and an example listing, refer to the *HP Instrument BASIC User's Handbook*.

To Save the Measurement Calibration

You can save an instrument state and measurement calibration to use for later measurements. When you recall an instrument state, the calibration that was set is also recalled.

1. If you are using a floppy disk, place a formatted disk in the disk drive you are using for data storage. If your disk is not formatted, refer to the procedure in "To Format a Floppy Disk" located later in this section.
2. Press **SAVE/RECALL** **Select Disk** and press the key that corresponds to the disk where you are going to save data.
 - Press **Internal Memory Prior Menu** if you are saving to the network analyzer internal non-volatile memory.
 - Press **Internal Disk Prior Menu** if you are saving to the internal disk drive.
 - Press **Configure Ext. Disk** if you are saving to an external disk drive.

- If you are configuring the network analyzer for the external disk drive, press the following keys:
 - **Ext. Disk Address** and enter the disk drive address
 - **Ext. Disk Volume** and enter the disk volume number
 - **Ext. Disk Unit** and enter the disk unit number
 - **Prior Menu External Disk Prior Menu**
- 3. Press **Define Save Cal ON Prior Menu**.
 - To save the calibration with the default filename of "STATE#," press **Save State**.
 - To save the calibration with your own filename, press **Re-Save State Clear Entry**, enter the filename, and press **Enter**.

Note



Both **Save State** and **Re-Save State** save the current information selected in the define save menu. Save automatically names the file "STATE#." Re-save enables you to choose the filename.

Renaming the Calibration File

- Connect a DIN keyboard to the network analyzer rear panel and type in the new filename. Refer to "Appendix B" located at the end of Chapter 7, "Reference and Menu Map," for information on substituting a DIN keyboard for all network analyzer front panel inputs.
- If you don't have a DIN keyboard, follow the steps below:
 - Press **File Utilities Rename File**.
 - Press **Backspace** repeatedly to erase the current filename from the network analyzer screen.
 - Use the front panel knob and **Select Character** key to point and select each character of the new filename.
 - Press **Enter** to rename the file you just saved.

Reference and Menu Map

Refer to this chapter to learn about the network analyzer. This chapter covers every control, feature, input, output, menu, hardkey, and softkey of the network analyzer. HP-IB mnemonics are not included in this chapter. To learn more about using the mnemonics and programming the instrument, refer to Chapter 9, "HP-IB Programming," in this manual and the (optional) IBASIC manual.

The menu map is distributed throughout this chapter under the hardkey entries.

Format of Entries

entry in bold: definition of entry. *See also* where else to look (if appropriate).

HARDKEY IN BUBBLE hardkey with labelled keycap and constant function. The **PRESET** hardkey returns the instrument to a known state (detailed in Appendix A at the end of this chapter). All other hardkeys present a menu (group of selections).

Softkey Shaded: unlabelled key next to CRT. Its function is defined by the current menu. The function is either an immediate action or display of another menu.

Reference

Numerical and Symbolic Entries

1> or **1:**: marker number one (of eight) in the marker menu. Makes marker number 1 the active marker and (if previously off) turns it on. ">" means the marker is the active marker. The active marker can be moved with the entry controls. ":" means the marker is not the active marker, it may be on or off. Two lines of numbers follow the marker annotation: the upper line indicates the frequency in MHz, the lower line amplitude. Amplitude is shown in dB in log mag format and as a unitless number in SWR format.

2> or **2:** through **8>** or **8:**: markers 2 through 8, as above.

3.5 mm: softkey in cal kit menu of 50 ohm instruments (see **CAL**). Selects type of cal kit as 3.5 mm. Coefficients for male and

A

female test ports are identical and based on the HP 85033C cal kit standards.

75 Ohm Formats: only in instruments with 75 ohm option, softkey in format menu. Displays 75 ohm format menu (see entry) for selection of graticule scaling.

75 ohm format menu: only in instruments with 75 ohm option, allows selection of graticule scaling in dBV, dBmV and dBuV.

/M: screen annotation, displayed in upper right corner when trace is "data divided by memory."

: "minus"/backspace hardkey. Use to enter negative numbers or to backspace to erase incorrect entries one character at a time.

↑: status notation. Indicates sweep in progress, normally on.

Alphabetical Entries

A: softkey in narrowband internal menu (see measurement menu). Selects tuned receiver measurement of input A (reflected power at the RF OUT port).

Abort: softkey in hardcopy menu (see **HARDCOPY**). Stops sending data from the network analyzer to the hardcopy device. Note: devices with large buffers may continue to operate for quite a while after this command. To stop such devices immediately, turn off power to the device.

Abort Cal: softkey in transmission cal, reflection cal, and detector zero menus (see **CAL**). Stops measurement calibration when selected before measurement of last calibration standard.

absolute measurements: display mode wherein graticule values are shown in absolute values. See also **Y-axis Lbl rel ABS**.

active channel: the display channel (1 or 2) affected by commands or entries. Indicated by a solid triangle on the CRT.

active marker: the marker affected by commands or moved by the front panel knob or up and down arrow keys.

Active Marker Off: softkey (see **MARKER**), turns off active marker and makes lowest numbered marker (if any) the active marker.

actual HP-IB address: the HP-IB address of an instrument as set by its physical switches or firmware. Range is 00 through 31. *See also* recognized HP-IB address, **HP8711 Address**.

Add Limit: softkey in limit-line menu (see **DISPLAY**). Displays menu to add limit lines or points to the limit table. *See also* limit-line menu.

Add Max Line: softkey in add limit menu (see **DISPLAY**). Displays add max line menu to add a maximum limit line. A maximum limit line is one which, with the limit test feature, displays a fail indication if the data trace extends above the line. *See also* limit-line menu.

add max line menu: one of the limit-line menus, sets: (1) begin (start) frequency and amplitude and (2) end (stop) frequency and amplitude of the limit line. Also allows use of a marker.

Add Max Point: softkey in add limit menu (see **DISPLAY**). Displays add max point menu to allow adding a maximum limit point. A maximum limit point is one which, with the limit test feature, displays a fail indication if the data trace extends above the (frequency) point. *See also* limit-line menu.

add max point menu: one of the limit-line menus, sets frequency and amplitude of the limit point. Also allows use of a marker. *See also* limit-line menu.

Add Min Line: softkey in add limit menu (see **DISPLAY**). Displays add min line menu to allow adding a minimum limit line. A minimum limit line is one which, with the limit test feature, displays a fail indication if the data trace falls below the line. *See also* limit-line menu.

add min line menu: same as the add max line menu (see entry).

Add Min Point: softkey in add limit menu (see **DISPLAY**). Displays add min point menu to allow adding a minimum limit point. A minimum limit point is one which, with the limit test feature, displays a fail indication if the data trace falls below the point. Limit points can be placed anywhere on the graticule. *See also* limit-line menu.

add min point menu: same as the add max point menu (see entry).

All Off: softkey in the marker menu (see **MARKER**). Turns off all of the markers, the delta marker, and marker tracking on the active channel.

Alpha: softkey in clock format menu. Formats the real-time internal clock to display the first three letters of the month (for example, Mar for March). *See also* **Clock Format**.

Alt Sweep on OFF: softkey (see **SWEEP** menu). When on, alternate sweep allows operation with different instrument states on its two displayed channels. When on, these settings of the two channels can differ: frequency span, detection option type, number of points, system bandwidth, trigger, sweep time. When off, the preceding settings match. Note: some settings, such as power level, always match. For examples of setting sweep time, see “Increasing Sweep Speed” in Chapter 6.

Amplifier: softkey (see **BEGIN** menu). Displays menu with selections suitable for amplifier measurements: transmission, reflection, and power. 1. Transmission menu settings: detection option B/R, frequency span 0.3 MHz to 1300 MHz, current transmission cal, log magnitude format, autoscale, marker to max, tracking off. 2. Reflection menu settings: detection option A/R, frequency span 0.3 MHz to 1300 MHz, default reflection cal, log magnitude format, autoscale, marker to min, tracking off. 3. Power menu settings: detection option B*, frequency span 10 MHz to 1300 MHz, calibration off (normalize if desired), detector zero autozero, log magnitude format, autoscale, marker to max, tracking off. For measurement examples, see “To Make a Power Measurement” in Chapter 4.

Annotation ON off: softkey in define graph menu (see **HARDCOPY**). When on (default setting), prints or plots screen annotation when **Graph and Mkr Table** or **Graph Only** is selected.

A/R: softkey in narrowband internal menu (see measurement menu). Selects tuned receiver reflection measurement A/R: input A (reflected power) divided by input R (reference signal).

Autofeed ON off: softkey in define printer and define plotter menus (see **HARDCOPY**). Toggles paper autofeed feature on and off. Default is on.

Autoscale: softkey (see **SCALE** menu). Scales the data trace vertically to fit within the graticule area of the display.

Autozero: softkey in detector zero menu (see calibration menu). Periodically compensates for detector drift due to changes in temperature. *See also* **Detector Zero**.

AUX INPUT: BNC connector on rear panel for low frequency, low voltage measurements. Maximum voltage: ± 10 V; maximum frequency: 200 Hz (40 Hz for best accuracy). For location, see Figure 1-3.

Average on OFF: softkey (see average menu). Turns on and off the averaging function. Averaging reduces random noise by averaging the measurement data from sweep to sweep. *See also* average menu, system bandwidth.

Average Factor: softkey (see average menu). Enters the averaging factor (number) in powers of 2. Default averaging factor is 16, max is 64.

average menu: sets averaging and system bandwidth with the softkeys below. For example, see “Reducing Trace Noise” in Chapter 6. For theory, see “Noise Reduction” in Chapter 8.

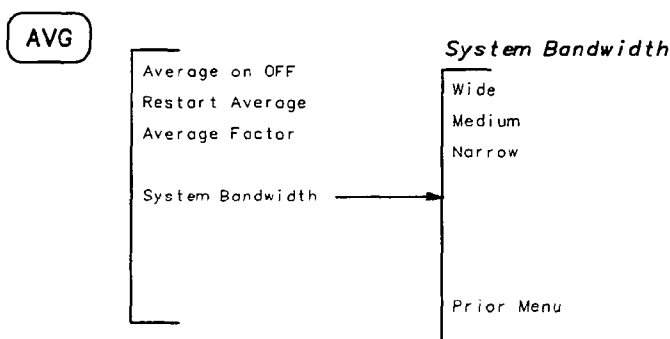

od619a

Figure 7-1. Average Menu

AVG: hardkey in the configure area. Displays the average menu (*see entry*).

B: softkey in the narrowband internal menu (see measurement menu). Selects tuned receiver transmission measurement of input B (power transmitted to RF IN port). *See also* narrowband.

B*: softkey in broadband internal menu (see measurement menu). Selects diode detector measurement of input B* (power transmitted to RF IN port). This is the “power” measurement detector.

Backspace: softkey in character entry menu (see **DISPLAY**). Deletes character to left of cursor, erases title one character at a time.

B

bandwidth: as in system bandwidth, bandwidth of IF filters in receiver section of network analyzer, determines receiver selectivity. Default is “medium.” In general, reducing bandwidth reduces trace noise and sweep speed; increasing bandwidth increases sweep speed. *See also* system bandwidth.

Bandwidth: softkey in marker search menu (see **MARKER**). For channel 1, transmission or power measurements in log format makes marker 1 a delta marker and sets it at frequency point of maximum amplitude, sets marker 5 at lower frequency -3 dB point, sets marker 6 at higher frequency -3 dB point, and sets marker 3 midway between markers 5 and 6. For filter measurements, marker 3 is the center frequency. Channel 2 uses markers 2, 7, 8, and 4. The softkey also displays the bandwidth (BW), center frequency (CF), Q, and transmission loss. **Bandwidth** also lets you change -3 dB default value to any other value.

Baud Rate: softkey in select copy port menu (see **HARDCOPY**). Sets transmission baud rate of network analyzer for serial devices. Make sure the rate set matches the requirement of the output device (see its manual for details).

Beeper Volume: softkey in system configuration menu (see **SYSTEM OPTIONS**). Sets beeper volume from off (0) to high (100). Default is 90. **PRESET** resets this to 90, cycling power does not affect it.

BEGIN: hardkey to left of disk drive. An appropriate place to begin measuring any of the four types of devices in the begin menu. Recommended for one channel measurements. For examples, see “Configuring Measurements from the BEGIN Key,” in Chapter 4, “Making Measurements.” For location, see Figure 1-2.

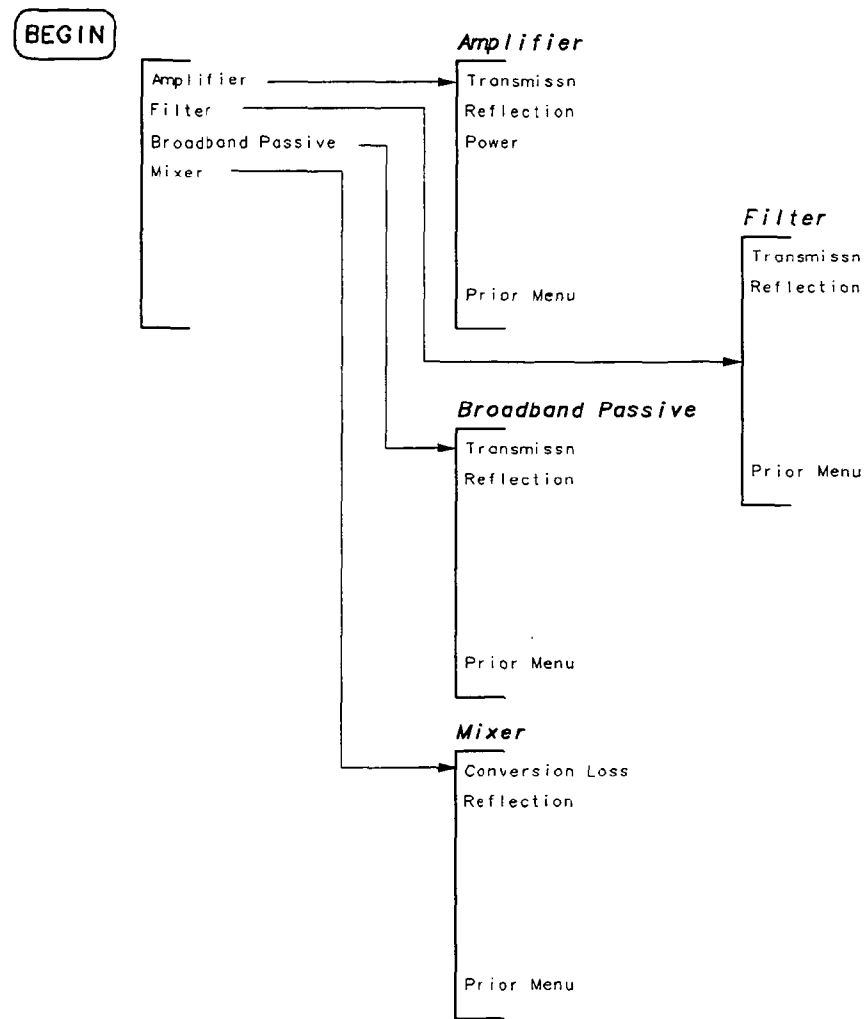

ad630a

Figure 7-2. Begin Menu

Begin Frequency: softkey in add max line and add min line menus (see **DISPLAY**). Sets the beginning (or start) frequency of the limit line highlighted in the limit-line table. *See also* limit-line menu.

Begin Limit: softkey in add max line and add min line menus (see **DISPLAY**). Sets the beginning (or start) amplitude (ie, dB) of the limit line highlighted in the limit-line table. *See also* limit-line menu.

B/R: softkey in narrowband internal menu (see measurement menu). Selects tuned receiver transmission measurement; ratio of input B (transmitted power) to input R (reference signal).

B*/R*: softkey in broadband internal menu (see measurement menu). Selects diode detector transmission measurement; ratio of

C

input B* (broadband transmitted power) to input R* (broadband reference signal).

broadband: diode detection mode, features wide frequency response and limited dynamic range, specified for frequency range of 10 MHz to 1300 MHz. Used for frequency translated measurements (for example, mixers) and total power measurements. *See also* narrowband. For examples, see “Measuring Devices with an HP 8711A Network Analyzer” in Chapter 4.

Broadband Internal: softkey in detection options menu (see measurement menu). Displays menu to select measurements made with internal diode detectors: B*, R*, or B*/R*. *See also* broadband.

Broadband External: softkey in detection options menu (see measurement menu). Displays menu to select measurements with external detectors at inputs X or Y or the broadband internal reference detector: X, Y, X/Y, Y/X and Y/R*. *See also* broadband.

Broadband Passive: softkey (see **BEGIN** menu). Displays menu with measurement selections suitable for cables, filters, and other passive devices: transmission and reflection. *See also* broadband. For measurement examples, see “Measuring Devices with an HP 8711A Network Analyzer” in Chapter 4.

C: screen annotation, displayed in upper right corner when trace thus annotated uses a user defined cal. *See also* measurement calibration.

C?: screen annotation, displayed in upper right corner when trace thus annotated uses a user defined cal and operating settings have changed.

CAL: hardkey in CONFIGURE area. Displays the calibration menu (see entry).

Cal Kit: softkey in cal menu (see entry). Allows selection of type of cal kit: type-N female (default), type-N male, 3.5 mm, or user defined (see entry). By convention, cal kits indicate the sex of the *port* with which they are used. For example the default cal kit for the analyzer is type-N *female* because the front panel test ports are female (the standards, in turn, are male). This same convention applies to whatever test “port” the standard is attached to, be it an adapter, cable, fixture, etc.

calibration menu: a selection of techniques to improve measurement accuracy by normalizing, removing systematic errors, or zeroing the detectors. *See also* measurement calibration. For examples, see

“To Make a Reflection Measurement” in Chapter 4. For theory, see “Measurement Calibration” in Chapter 8, “How the Analyzer Works.”

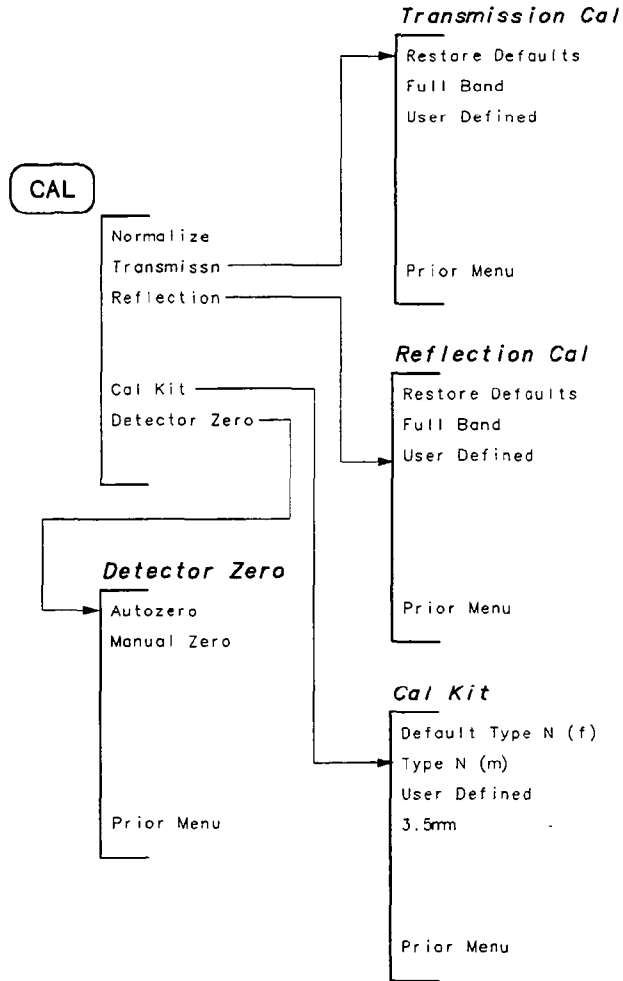

ad66a

Figure 7-3. Calibration Menu

Cancel: softkey in character entry menu (see **DISPLAY**). Cancels current title entry and displays former title, if any, prior to use of **Enter**.

Center: softkey (see frequency menu). Sets center frequency of internal RF source and changes screen annotation to center and span. *See also* span.

Chan Off: softkey (see measurement menu). Turns active channel off. *See also* active channel.

CHAN 1: hardkey in MEAS area (see measurement menu). Turns on channel 1 as the active channel. Default is transmission measurement.

CHAN 2: hardkey in MEAS area (see measurement menu). Turns on channel 2 as the active channel. Default is channel off; selecting it changes setting to the most recent type of measurement.

Change Directory: softkey in directory utilities menu (see **SAVE RECALL**). Use knob or entry arrow keys to highlight target directory, then press **Change Directory**. When target directory is a subdirectory, it selects that subdirectory. When target directory is "Parent Dir," it selects the higher directory of the current one.

channel: in the HP8711: 1. One of two display channels: channels 1 and 2, each of which can show similar information or act independently (see **Alt Sweep**). 2. One of seven input paths: A, B, R, B*, R*, X, Y

Char Entry: on-screen title of character entry menu (see **DISPLAY** or **SAVE RECALL** menu).

character entry menu: menu displayed by several softkeys. Displays rudimentary line editor to edit screen, file, or program titles. Allows user to add a character or space, delete a character, enter the title when it is correct, or clear the displayed entry.

Clear Entry: softkey in character entry menu (see **DISPLAY** or **SAVE RECALL** menu). Clears entire title and recalls previous title (if any) when pressed prior to **Enter**.

Clear Program: only in network analyzers with IBASIC option, softkey in utilities menu (see **SYSTEM OPTIONS**). Clears (erases) the current IBASIC program from internal memory. For details, see *HP Instrument BASIC User's Handbook*.

Clock Format: softkey in set clock menu (see **SYSTEM OPTIONS**). YYYY stands for year. MM stands for month. DD stands for day. HH stands for hour, 24 hour mode. MM stands for minute. In numeric format, the month is displayed by number (for example, March is 03). In alpha format, the first three letters of the month are displayed (for example, Mar). To display the clock on screen, press **DISPLAY More Display Title and Clock Show Clock on Line...** **Title+Clk ON**. To not print or plot the clock, use **Title+Clk** key in **HARDCOPY** menu. To set clock, see **Set Clock**.

Clock Off: softkey in title and clock menu (see **DISPLAY**). Prevents clock from being displayed in the title area; toggles with **Show Clock on Line**...

Color: softkey in define printer and define plotter menus (see **HARDCOPY**). Toggles with **Monochrome** to define printer or plotter as one color (black and white) or multi-color.

CONFIGURE: front panel area with six hardkeys: **SCALE**, **DISPLAY**, **CAL**, **MARKER**, **FORMAT**, and **AVG**. For location, see Figure 1-2.

Configure Ext Disk: softkey in select disk menu (see **SAVE RECALL**). Displays menu to set the HP-IB address, unit number, and volume number of the external disk drive. For details, see the disk drive manual.

Continue: only in network analyzers with IBASIC option, softkey in IBASIC menu (see **SYSTEM OPTIONS**). Restarts a program that has been paused. *See also HP Instrument BASIC User's Handbook.*

Continuous: softkey in trigger menu (see source menu). Default trigger mode; network analyzer begins next sweep at conclusion of current sweep. *See also Trigger.*

Conversion Loss: softkey in mixer menu and measurement menu, for frequency translated devices, selects a broadband internal transmission measurement. 1. Mixer menu settings: detection option B*/R*, frequency span 10 MHz to 1300 MHz, calibration off (normalize if desired), detector manual zero, log magnitude format, autoscale, marker to max, tracking off. 2. Measurement menu settings: detection option B*/R*, frequency span 0.3 MHz to 1300 MHz, calibration off (normalize if desired), detector autozero, log magnitude format, reference at 0 dB, 10 dB per division. For examples of measurements, see "To Make a Conversion Loss Measurement" in Chapter 4.

Copy All Files: softkey in file utilities menu (see **SAVE RECALL**). Displays catalog of files and copy disk menu to select destination disk. Destination can be internal memory, internal disk, or external disk.

Copy File: softkey in file utilities menu (see **SAVE RECALL**). Displays catalog of files and copy disk menu to select destination disk. Destination can be internal memory, internal disk, or external disk. If source and destination are the same, rename file. This key also allows copying from directory to directory.

D

Copy to Int Disk: softkey in copy file menu (see **SAVE RECALL**). Displays character entry menu to rename file (if desired) prior to copying. Note: in this menu, **Enter** begins the copy process to the internal disk drive with the filename entered.

Copy to Int Memory: softkey in copy file menu (see **SAVE RECALL**). Displays character entry menu to rename file (if desired) prior to copying. Note: in this menu, **Enter** begins the copy process to internal memory with the filename entered.

Copy to Ext Disk: softkey in copy file menu (see **SAVE RECALL**). Displays character entry menu to rename file (if desired) prior to copying. Note: in this menu, **Enter** begins the copy process to the external disk with the filename entered.

correction constants: error correction constants calculated by the network analyzer during adjustment tests and applied to measurement data to improve accuracy. *See also* error correction arrays.

CW: softkey (see frequency menu). Selects CW (continuous wave, single frequency) source operation.

D Data: softkey (see **DISPLAY** menu). Displays the current measurement data.

data?: status notation in upper left corner of screen. Indicates that the network analyzer source or receiver parameters have been changed since last complete sweep. May indicate that the network analyzer is in “Hold” trigger mode.

Data->Mem: softkey (see **DISPLAY**). Stores the active data trace in the memory of the active channel. For examples, see “Displaying Measurement Traces” in Chapter 5.

Data/Mem: softkey (see **DISPLAY**). Divides trace data by data in memory. For this key to function, you must select **Data->Mem** and store a data trace in memory.

Data and Memory: softkey (see **DISPLAY**). Displays both the current data and memory traces, with identical scaling and format. You must select **Data->Mem** first for this key to function. Note: use care in interpreting memory trace values. The memory trace may have been stored under conditions different from the current measurement trace. For examples, see “Displaying Measurement Traces” in Chapter 5.

DD-MM-YYYY HH:MM: softkey in clock format menu. Formats the real-time internal clock to display time as Day-Month-Year Hour:Minute. *See also* **Clock Format**.

Default Pen Colors: softkey in set pen numbers menu (see **HARDCOPY**). Resets pen number assignments to their default values. *See also* appendix A at the end of this chapter.

Default Type-N(f): softkey in cal kit menu (see **CAL**). Selects type of cal kit as type-N, female. This is the default cal kit for the analyzer (see **Cal Kit** for details).

Define Graph: softkey in define hardcopy menu (see **HARDCOPY**). Displays menu to define which parts of the graph are to be printed or plotted: trace data, graticule, annotation, marker symbol, title and clock, or combinations.

Define Hardcopy: softkey (see **HARDCOPY**). Displays menu to define the hardcopy in terms of information to be copied. Default setting is **Graph and Mkr Table**.

Define Plotter: softkey (see **HARDCOPY**). Displays menu to define the printer in terms of color, pen numbers, and autofeed.

Define Printer: softkey (see **HARDCOPY**). Displays menu to define the printer in terms of color, orientation, autofeed, resolution, and margins.

Define Save: softkey (see **SAVE RECALL**). Displays menu to save the instrument state, measurement calibration, measurement data, or combinations. Allows choice of saving trace data in ASCII format for output to spreadsheets. ASCII format is compatible with Lotus 1-2-3.

Delete All Files: softkey in file utilities menu (see **SAVE RECALL**). Displays **YES** and **NO** softkeys to delete or cancel deleting all files. Also deletes empty directories on DOS disks.

Delete All Limits: softkey in delete limit menu (see **DISPLAY**). Deletes all of the limit lines in the limit-line table. *See also* limit-line menu.

Delete Char: softkey in character entry menu (see **DISPLAY**), for use with external keyboards.

Delete File: softkey in file utilities menu (see **SAVE RECALL**). Displays table of files and keys to delete (or cancel deleting) the highlighted file. Highlight the target file first, then press **Delete File**.

Delete Limit: softkey in limit-line menu (see **DISPLAY**). Displays menu to delete one segment (or point) of a limit line or all limits. *See also* limit-line menu.

delete limit menu: allows deletion of one or all limits in current table. *See also* limit-line menu.

Delta Mkr on OFF: softkey (see **MARKER**). Makes the active marker the delta marker or reference point. Indicated by a small delta symbol below the marker icon. In delta marker mode, marker values are the offset values from the delta marker. For example, assume marker 1 is the delta marker: if marker 2 reads 2.1 MHz, it is 2.1 MHz higher than marker 1; if marker 3 reads -1.4 MHz, it is 1.4 MHz lower than marker 1. Also applies to amplitude values.

Detection Options: softkey (see measurement menu). Selects measurement type: narrowband or broadband internal, broadband external or aux input. Narrowband internal measurements are tuned receiver type internal to the instrument. Broadband internal measurements are internal diode detection type. Broadband external measurements use external diode detectors. *See also* narrowband, broadband, and aux input.

Detector Zero: softkey (see calibration menu). Displays detector zero menu for selection of type of detector zeroing (compensating for drift). Default is autozero. Only internal or external detectors in use are zeroed. In autozero mode, the network analyzer zeroes on selection and as required (about every five minutes depending on ambient temperature). In manual zero mode, the network analyzer zeroes once each time **Manual Zero** is pressed. Note: do not apply RF power to detector during zeroing. With an external source, use **Manual Zero** to coordinate RF power off with zeroing.

DIN KEYBOARD: 5-pin DIN connector on rear panel. For use with optional keyboard (must be IBM PC/AT compatible). Location shown in Figure 1-3.

Directory Utilities: softkey in file utilities menu (see **SAVE RECALL**). Displays menu to change, make, or remove a directory.

disk: usually means floppy disk or disk drive but can also refer to non-volatile SRAM (a RAM disk).

disk drive: device that stores data onto and retrieves data from a disk (shown in Figure 1-2).

DISPLAY: hardkey in configure area of front panel. Displays menu with selections concerning type of data to be displayed, split or full screen, title and limit lines. See also limit-line menu, Split Display, "Displaying Measurement Traces" in Chapter 5.

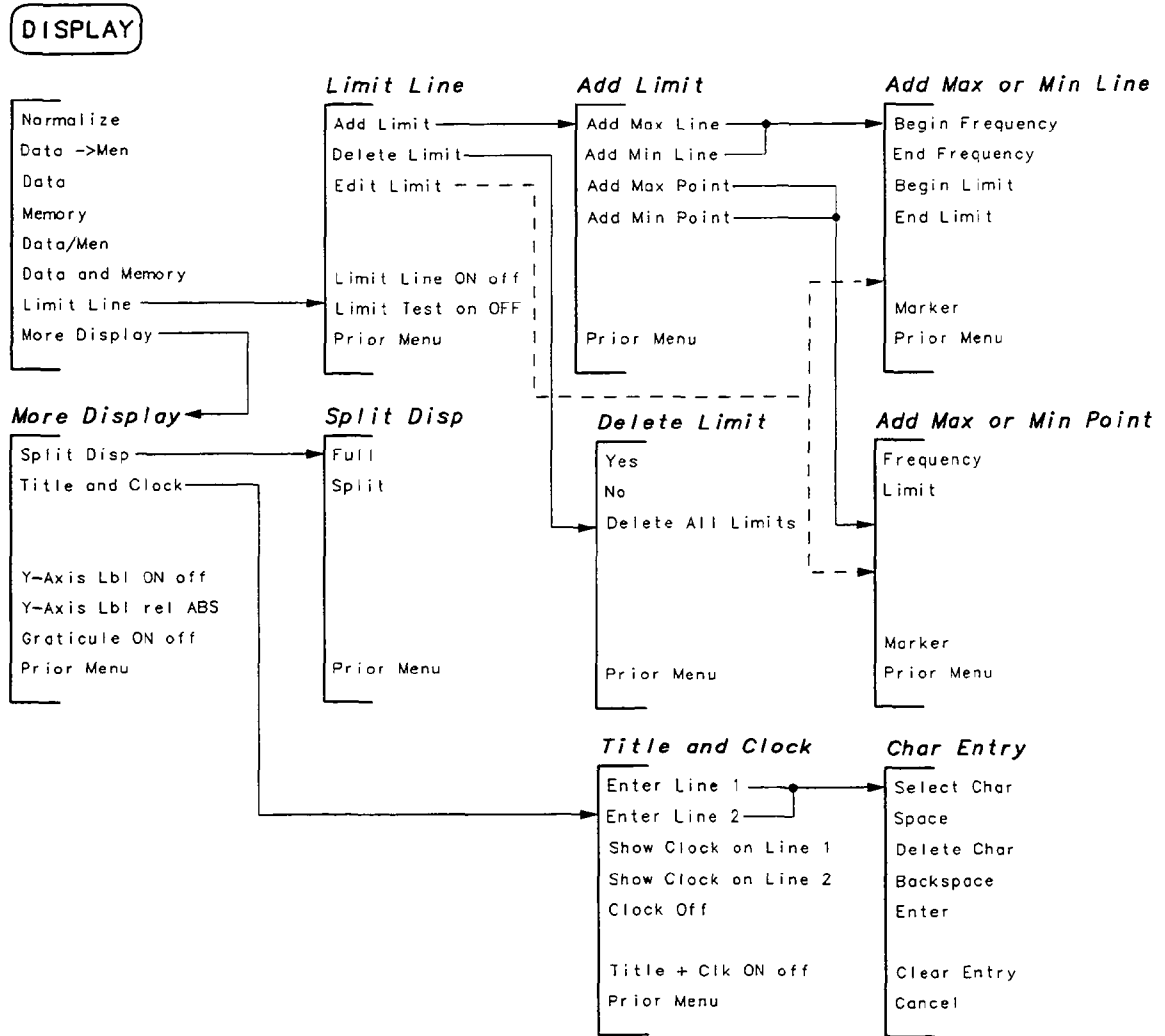

ad631a

Figure 7-4. Display Menu

Disp Freq Resolution: softkey (see frequency menu). Selects frequency resolution to be displayed: MHz, kHz, or Hz. For example, a frequency of 1,234,567 Hz can be displayed as: 1 MHz (note rounding down), 1.235 MHz (note rounding up), or 1.234 567 MHz. Default is kHz.

E

Dither on OFF: softkey (see source menu). When on, shifts spurs which may be visible in low level measurements or small scale/division high level measurements. Recommended for small frequency spans; no sweep speed penalty. With this feature, some spurs within band may be shifted out of band, some spurs out of band may be shifted within band. Most effective with a user defined cal. *See also* spur avoid menu.

DTR/DSR: softkey in select copy port menu (see **HARDCOPY**). A hardware handshake for some serial devices. Toggles with **Xon/Xoff** (see entry).

E Edit: only in network analyzers with IBASIC option, softkey in IBASIC menu (see **SYSTEM OPTIONS**). Displays the IBASIC edit menu and a rudimentary word and character editor. For details, see *HP Instrument BASIC User's Handbook*.

Edit Limit: softkey in limit-line menu (see **DISPLAY**). Displays menu to (1) change the frequency or amplitude of previously entered limits or (2) add a data trace marker. *See also* limit-line menu.

End Frequency: softkey in add max line and add min line menus (see **DISPLAY**). Sets the end (or stop) frequency of the limit line highlighted in the limit-line table. *See also* limit-line menu.

End Limit: softkey in add max line and add min line menus (see **DISPLAY**). Sets the end (or stop) amplitude (height) of the limit line highlighted in the limit-line table. *See also* limit-line menu.

End Line #: softkey in secure menu of instruments with IBASIC option. Not shown in this manual; for details see *HP Instrument BASIC User's Handbook*.

Enter: softkey in character entry menu (see **DISPLAY** or **SAVE RECALL**). Enters the current title as the screen or file title.

Enter Line 1: softkey in title and clock menu (see **DISPLAY**). Displays character entry menu to edit screen title on line 1 of display. Maximum number of characters is 36.

Enter Line 2: as above, but edits line 2.

ENTRY: area of front panel with keys, knob, and up and down arrows for data entry (shown in Figure 1-2).

error correction arrays: 1. Correction arrays calculated by the network analyzer during full band or user defined measurement calibrations. 2. Resident correction arrays calculated by an

adjustment test and stored in memory for use with the default measurement calibration. For examples, see “To Make a Reflection Measurement,” Chapter 4; for theory, see “Measurement Calibration” in Chapter 8.

error messages: on-screen information about error state (or instrument activity or status), self-explanatory, not documented elsewhere. In case of difficulty, refer to the Service Manual.

EXT DET X-INPUT: connector on rear panel. Powers an external detector and accepts its input for processing and display. *See also* measurement menu, for compatible detectors, see Chapter 2. Location shown in Figure 1-3.

EXT DET Y-INPUT: connector on rear panel. Powers an external detector and accepts its input for processing and display. *See also* measurement menu; for compatible detectors, see Chapter 2. Location shown in Figure 1-3.

external detector: diode detector which can be used with the network analyzer for remote measurements. For compatible detectors, see Chapter 2.

External Disk: softkey in select disk menu (see **SAVE RECALL**). Selects external disk drive as the location to save data to and recall data from.

Ext Disk Address: softkey in select disk menu (see **SAVE RECALL**). Sets the HP-IB address of the external disk drive; default is 0 (zero).

Ext Disk Unit: softkey in select disk menu (see **SAVE RECALL**). Sets the unit number of the external disk drive; default is 0 (zero).

Ext Disk Volume: softkey in select disk menu (see **SAVE RECALL**). Sets the volume number of the external disk drive; default is 0 (zero).

external: a type of broadband measurement made with external detectors or bridges. *See also* **Broadband External**.

External CRT Adjust: softkey in system configuration menu (see **SYSTEM OPTIONS**). Displays menu to set external CRT timing parameters for best image; not affected by preset. Note: these adjustments also affect the internal CRT of the network analyzer.

External Disk: softkey in select disk menu (see **SAVE RECALL**). Selects the external disk as the location where information is saved, re-saved, or recalled. Selection shown on-screen as “Ext.” *See also* **Select Disk**.

F

External Point: softkey in trigger source menu (see source menu). Enables network analyzer to sweep to next (frequency) point when externally triggered through EXT TRIG IN/OUT rear panel connector, one point per trigger. *See also* ext trig in/out, **Trigger**.

External Sweep: softkey in trigger source menu (see source menu). Enables network analyzer to begin one sweep when externally triggered. *See also* EXT TRIG IN/OUT, **Trigger**.

EXT REF IN: BNC connector on rear panel, for use of an external 10 MHz signal (>−5 dBm required) as the frequency reference, must be with **Ext Ref ON**. Location shown in Figure 1-3.

Ext Ref OFF on: softkey (see source menu). When on, sets network analyzer to use external 10 MHz signal as frequency standard. When off, if signal is not present at EXT REF IN connector, network analyzer will not sweep. Default is off. Note: external reference should be disconnected from EXT REF IN or power reduced when not in use.

EXT TRIG IN/OUT: BNC connector on rear panel. TTL open collector circuit. High input to network analyzer triggers sweep or point measurement. When measurement is done, network analyzer outputs low signal for >1 usec. *See also* external sweep, external point. Location shown in Figure 1-3.

F fan: part of power supply assembly, inside PS/display enclosure. Cools the network analyzer by exhausting air from the network analyzer.

File Utilities: softkey (see **SAVE RECALL**). Displays menu to rename, delete, or copy files; format disk or memory; and change or make directories.

Filter: softkey (see **BEGIN**). Displays menu to select measurements optimal for filters: transmission and reflection. 1. Transmission settings: detection option B/R, frequency span 0.3 to 1300 MHz, default transmission cal, log mag format, autoscale, marker to max, tracking off. 2. Reflection settings: detection option A/R, frequency span 0.3 to 1300 MHz, default reflection cal, log mag format, autoscale, marker to min, tracking off. For measurement examples, see “Measuring Devices with an HP 8711A Network Analyzer” in Chapter 4.

FORMAT: hardkey in configure area. Sets format of measurement data with the following menu. Seventy-five ohm formats are displayed only in 75 ohm instruments. Formats are linked within five parameter (measurement) groups. *See also* pfr couplings.

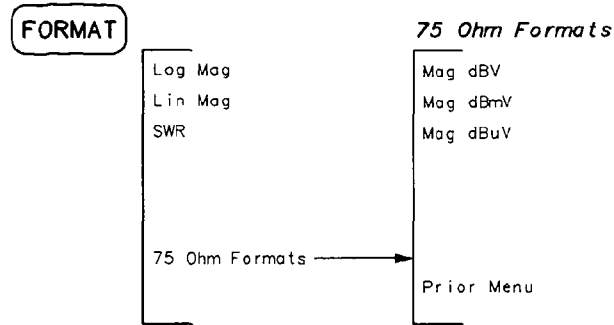

ad68a

Figure 7-5. Format Menu

Format Disk: softkey in file utilities menu (see **SAVE RECALL**). Displays table of files and format disk menu to select disk. Disk can be internal memory, internal disk, or external disk. Note: the network analyzer formats disks in DOS only but can read and save to DOS- and LIF-formatted disks. To format in LIF, use IBASIC (optional) or an external computer and disk drive. For examples, see “To Format a Floppy Disk,” Chapter 5.

Format Int Disk: softkey in format disk menu (see **SAVE RECALL**). Formats the disk in the internal disk drive in DOS format.

Format Int Memory: softkey in format disk menu (see **SAVE RECALL**). A fast way to erase all directories and files in the internal memory.

Format Ext Disk: softkey in format disk menu (see **SAVE RECALL**). Formats the disk in the external disk drive in DOS format.

FREQ: hardkey in source area. Displays frequency menu (following).

Frequency: softkey in add max point and add min point menus (see **DISPLAY**). Sets frequency of limit point. *See also* limit-line menu.

F

frequency menu: its keys control the frequency of the internal RF source and set the frequency resolution displayed. Start is paired with stop; center is paired with span. Pressing any one of those keys makes it the active function and displays it and its pair beneath the graticule. CW stands for continuous wave (one frequency). Default resolution is kHz.

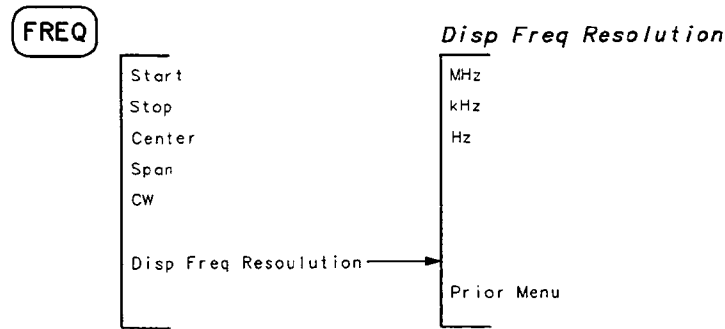

od632a

Figure 7-6. Frequency Menu

Full: softkey in split display menu (see **DISPLAY**). Displays one or both channels on a single full-sized graticule on the CRT. *See also Split Disp.*

Full: in network analyzers with IBASIC option, softkey in IBASIC display menu (see **SYSTEM OPTIONS**). Displays the IBASIC program on the full screen without measurement data. *See also Upper.* For details, see *HP Instrument BASIC User's Handbook*.

full band: full frequency span; in this network analyzer, 0.3 to 1300 MHz.

Full Band: softkey in transmission and reflection calibration menus (see calibration menu). A full frequency span cal of 801 points. Useful for calibrating systems with attenuators, filters, amplifiers, etc. in the measurement path. You can reduce the frequency span or number of points after calibration if desired. A convenient cal for measurements over a variety of frequencies, but not as accurate as the user defined cal for a single frequency range. When selected, it erases a user defined cal, if any. When the default or user defined cal is selected, this cal is erased. *See also* calibration menu, measurement calibration.

G **Graph and Mkr Table**: softkey in define hardcopy menu (see **HARDCOPY**). Defines hardcopy to print both graph and marker table. Note: marker table prints only if one or more markers are on. See also **Define Graph**.

Graph Only: softkey in define hardcopy menu (see **HARDCOPY**). Defines hardcopy as the graph. Note: the components of the graph are defined by **Define Graph**.

Graphics: softkey in set pen numbers menu (see **HARDCOPY**). Sets pen number assignment (color) for annotation on hardcopy.

Graticule: softkey in set pen numbers menu (see **HARDCOPY**). Sets pen number assignment (color or width) for grid on hardcopy.

Graticule ON off: softkey in more display menu (see **DISPLAY**) and define graph menu (see **HARDCOPY**). 1. More display menu: affects what is visible on the CRT, turns on (default) and off the horizontal and vertical lines of the graticule (or grid) but not its border. 2. Define graph menu: affects what is printed or plotted, turns on (default) and off grid and border when **Graph and Mkr Table** or **Graph Only** is selected. 3. Note: border prints but not grid when graticule is set to print but is NOT visible on screen.

green LED: on rear panel, normally on when the network analyzer is plugged in (on or standby). If off or if red LED is on, unplug the network analyzer and refer to the Service Manual for help.

H **HARDCOPY**: one of four hardkeys in SYSTEM area of front panel. Displays menu to start or stop prints or plots, set up the printer or plotter, and determine the appearance of the copy. For example of use, see "Printing and Plotting Measurement Results" in Chapter 5.

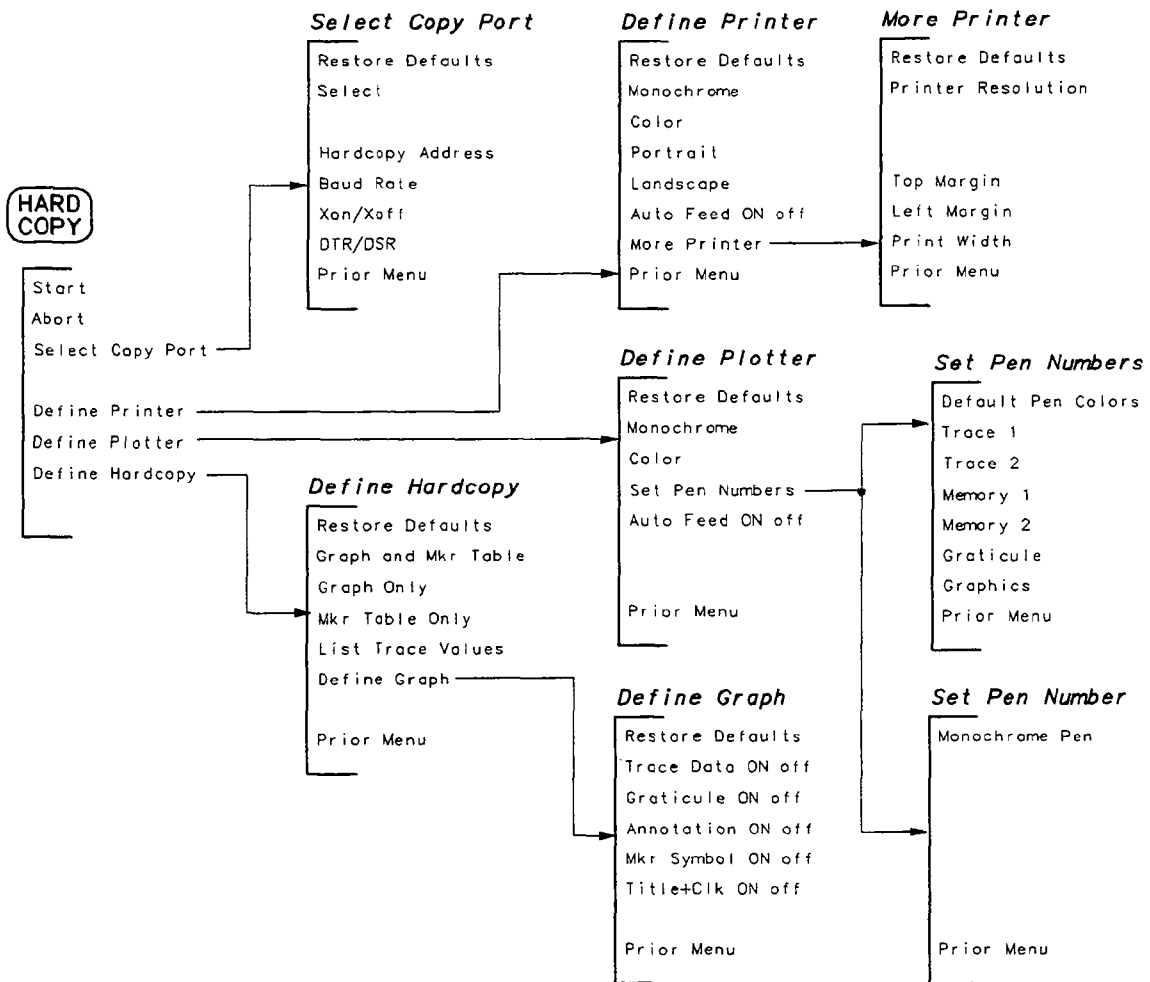

ad633a

Figure 7-7. Hardcopy Menu

Hardcopy Address: softkey in select copy port menu (see **HARD COPY**). Sets recognized HP-IB address of hardcopy device at HP-IB port, for HP-IB printers and plotters only. Default address is 5. The “recognized HP-IB address” is the address that the network analyzer uses to communicate with the device. The actual address of the device must be set independently to match.

Hardcopy All: softkey in operating parameters menu (see **SYSTEM OPTIONS**). Prints copy of all four operating parameter screens.

Hardcopy Screen: softkey in operating parameters menu (see **SYSTEM OPTIONS**). Prints copy of displayed operating parameter screen.

HARDKEY: one of 17 labeled keys (or buttons) on the front panel, for example **BEGIN**. Most source and configure hardkeys automatically activate an entry selection; for example, pressing **POWER** activates the power Level setting. Typographic convention: **CAPITAL LETTERS IN BUBBLE**. See also **Softkey**.

Hold: softkey in trigger menu (see source menu). Stops the current data trace sweep immediately and holds sweep until **Continuous** or **SINGLE** is selected. See also **Trigger**.

Horizontal Back Porch: softkey in external CRT adjustment menu (see **SYSTEM OPTIONS**). CRT timing adjustment for use with external monitors. Also affects network analyzer's internal CRT. Default setting is 3.6 usec. See also **VIDEO OUT**.

Horizontal Frnt Porch: softkey in external CRT adjustment menu (see **SYSTEM OPTIONS**). CRT timing adjustment for use with external monitors. Also affects network analyzer's internal CRT. Default setting is 41.4 usec. See also **VIDEO OUT**.

HP8711 Address: softkey in HP-IB (see **SYSTEM OPTIONS**). Sets actual HP-IB address of the network analyzer. Default HP-IB address is 16. Setting is not affected by **PRESET** or power-on.

HP-IB: softkey (see **SYSTEM OPTIONS**). Displays menu to (1) set actual HP-IB address of network analyzer, (2) set and change network analyzer HP-IB status, and (3) set HP-IB echo feature. See also actual HP-IB address, recognized HP-IB address, **HP-IB Echo**.

HP-IB: Hewlett-Packard Interface Bus is Hewlett-Packard's hardware, software, documentation, and support for IEEE 488.1 and IEC-625, world-wide standards for interfacing instruments. Also known as GP-IB (general purpose interface bus).

HP-IB: connector on rear panel. Connects the network analyzer to instruments with HP-IB interface for communication and control. Instrument examples include external controller, printer, plotter, etc. Location shown in Figure 1-3.

HP-IB Echo on OFF: softkey in HP-IB menu (see **SYSTEM OPTIONS**). When on, displays HP-IB mnemonics on screen as keys are pressed, a convenient way to see the mnemonics associated with the keys. Note: not all keys (especially those that display menus) have mnemonics.

Hz: softkey in display frequency resolution menu (see frequency menu). Displays frequency to Hz resolution. For example, 1.234 567 MHz is displayed as 1.234 567 MHz. *See also* **Disp Freq Resolution**.

- I **IBASIC**: optional controller embedded in the network analyzer, allows network analyzer to run programs and control other instruments. A subset of HP-BASIC programming language.

IBASIC: softkey (see **SYSTEM OPTIONS**). Displays IBASIC menu in instruments with that option. IBASIC menu functions include run, continue, step, edit, key record, and clear. *See also* **Key Record**.

IBASIC Display: only in network analyzers with IBASIC option, softkey in IBASIC menu (see **SYSTEM OPTIONS**). Displays a menu to not show an IBASIC program, show it on the full screen, or show it on half screen. For details, see *HP Instrument BASIC User's Handbook*.

Instrument Info: softkey in service menu (see **SYSTEM OPTIONS**). Displays information about the network analyzer: firmware revision and date, bootROM version, serial number, options, system impedance, and amount of memory. To see this information, press **SYSTEM OPTIONS Service Instrument Info**. Detailed information on the service menus is in the *HP 8711A RF Network Analyzer Service Manual*.

instrument state: 1. In general: data consisting of the learn string, memory traces, and calibration data. The learn string consists of the stimulus and response parameters that set up the network analyzer to make a specific measurement. The instrument state is saved to non-volatile SRAM at power-down and recalled at power-up. 2. In terms of save-recall operations: data consisting of the learn string and memory trace data (if in use). For examples of save-recall operations and amount of memory used, see Appendix C at the end of this chapter.

Instrument State ON off: softkey in define save menu (see **SAVE RECALL**). When on, allows save of instrument state.

intensity control: on left side of CRT. Adjusts the brightness of the CRT (location shown in Figure 1-2).

Internal: softkey in trigger source menu (see source menu). Default mode, network analyzer is triggered automatically (in **Continuous** mode) or as desired (in **Single** mode). *See also* **Trigger**.

Internal Disk: softkey in select disk menu (see **SAVE RECALL**). Selects the internal disk as the location where information is saved, re-saved, or recalled. Selection shown on-screen as "Int." *See also Select Disk.*

Internal Memory: softkey in select disk menu (see **SAVE RECALL**). Selects the internal memory as the location where information is saved, re-saved, or recalled. Selection shown on-screen as "Mem." *See also Select Disk.*

J

K keyboard: optional accessory, must be IBM AT/PC compatible. For equivalent front panel keystrokes see Appendix B at the end of this chapter.

Key Record on OFF: only in network analyzers with IBASIC option, softkey in IBASIC menu (see **SYSTEM OPTIONS**). Translates front panel keystrokes into program lines to automatically set up and run network analyzer. Press **SYSTEM OPTIONS** **IBASIC**

Key Record ON **PRESET** to begin program. Press **SYSTEM OPTIONS** **IBASIC** **Key Record OFF** to end program. Only one program can be stored in memory at a time, but programs can also be stored to internal and external disks. For IBASIC details, see *HP Instrument BASIC User's Handbook*.

kHz: softkey in display frequency resolution menu (see frequency menu). Displays frequency to kHz resolution. For example, 1.234 567 MHz is displayed as 1.235 MHz (note rounding up). *See also Disp Freq Resolution.*

L

Landscape: softkey in define printer menu (see **HARDCOPY**). Sets printer to print hardcopy so that paper is oriented with longer edge at top and shorter edges at sides. Toggles with **Portrait**.

LEDs: light emitting diodes, visible from rear of instrument. Green LED near bottom edge of network analyzer indicates status of power supply. Green LEDs visible through **TEST RESULTS** opening are part of the CPU board. In case of difficulty, see the service manual. *See also green LED*. Location shown in Figure 1-3.

Left Margin: softkey in more printer menu (see **HARDCOPY**). Sets left margin (non-printing space) in mm (25.4 mm = 1.00 inches). Minimum setting is 0.00 mm (default); maximum is 200 mm.

Level: softkey (see **POWER**). Sets RF power level of source as shown below.

| Instrument | Minimum | Maximum (<1000 MHz) | Maximum (>1000MHz) |
|---------------|---------|------------------------|-----------------------|
| Standard | 0 dBm | +16 dBm | +13 dBm |
| opt 1E1 | -60 dBm | +13 dBm | +10 dBm |
| opt 1EC | 0 dBm | +13 dBm | +10 dBm |
| opt 1E1 & 1EC | -60 dBm | +10 dBm | +7 dBm |

Limit: softkey in add max point or add min point menus (see **DISPLAY**). Sets amplitude of limit point. *See also* limit-line menu.

Limit Line: softkey in display menu (see **DISPLAY**). Displays limit-line menu (see below) to display, add, delete, and edit limit lines, and select limit test.

limit line: user-defined line or point that can indicate specifications, test limits, etc. of the device under test. *See also* **Limit Test**.

limit line menu: allows user to display, add, delete, and edit limit lines, and select limit test. For an example of using this feature, see "Limit Testing" in Chapter 5.

Limit Line on OFF: softkey in limit line menu (see **DISPLAY**). When on, limit lines or points in limit table are visible on the CRT. *See also* limin-line menu.

Limit Test on OFF: softkey in limin-line menu (see **DISPLAY**). Sets limit test status. When limit test is on, measurement data exceeding a limit line displays "FAIL" on the CRT. The limit line need not be visible. *See also* limin-line menu.

LIMIT TEST TTL IN/OUT: BNC connector on rear panel. Part of a bidirectional open-collector TTL signal which can be accessed from IBASIC. The output goes high when the limit test passes. Location shown in Figure 1-3.

line voltage selector switch: on rear panel. Sets network analyzer for use with nominal line voltages of 115 VAC or 230 VAC. Location shown in Figure 1-3.

Lin Mag: softkey in format menu (see entry). Displays transmission trace in transmission coefficient, reflection trace in reflection coefficient, aux input trace in volts (from 1 mV/div to 20 V/div).

listener: an HP-IB device addressed to receive data or commands over the bus. *See also* **Talker/Listener**, **System Controller**.

List Trace Values: softkey in define hardcopy menu (see **HARDCOPY**). Defines hardcopy as a list of data trace values (frequency and amplitude), one pair for each data point. Note: plotting lists with many data points can be very time consuming.

Log Mag: softkey (see **FORMAT**). Displays the logarithmic magnitude of the data in dB. *See also* SWR.

Lower: only in network analyzers with IBASIC option, softkey in IBASIC display menu (see **SYSTEM OPTIONS**). Displays the IBASIC program on the lower half of the screen and measurement data on the upper half. For details, see *HP Instrument BASIC User's Handbook*.

M **Mag dBmV**: softkey in 75 ohm formats menu (see **FORMAT**). In 75 ohm instruments, displays the data scaled in dBmV per division.

Mag dBuV: softkey in 75 ohm formats menu (see **FORMAT**). In 75 ohm instruments, displays the data in dBuV per division.

Mag dBV: softkey in 75 ohm formats menu (see **FORMAT**). In 75 ohm instruments, displays the data in dBV per division.

Make Directory: softkey in directory utilities menu (see **SAVE RECALL**). Displays character entry menu for entry of directory name. Note: in this menu, **Enter** enters directory name and makes the directory.

Manual Zero: softkey in detector zero menu (see calibration menu). Compensates for detector drift once when selected. Recommended setting with external RF source at detectors to coordinate RF off and zeroing. *See also* **Detector Zero**.

marker: an icon (small triangle) that identifies a frequency point and the value of the measured data at that frequency. Markers are continuous in frequency (they indicate interpolated values between measured frequency points). To determine the value of the data at a specific frequency, use the entry controls to move the active marker to that frequency. To determine frequencies at which specified values occur, use **Target Search** (see entry).

Markers also provide capabilities for reducing measurement time by changing stimulus parameters (see **Marker -> Center**, **Marker -> Reference**), searching the trace for specific values (see **Marker Search**), or statistically analyzing part or all of the trace (see **Bandwidth**).

M

MARKER: hardkey in CONFIGURE area. Displays menu to set markers, use marker search and delta markers. For examples, see “Activating Marker Functions” in Chapter 5.

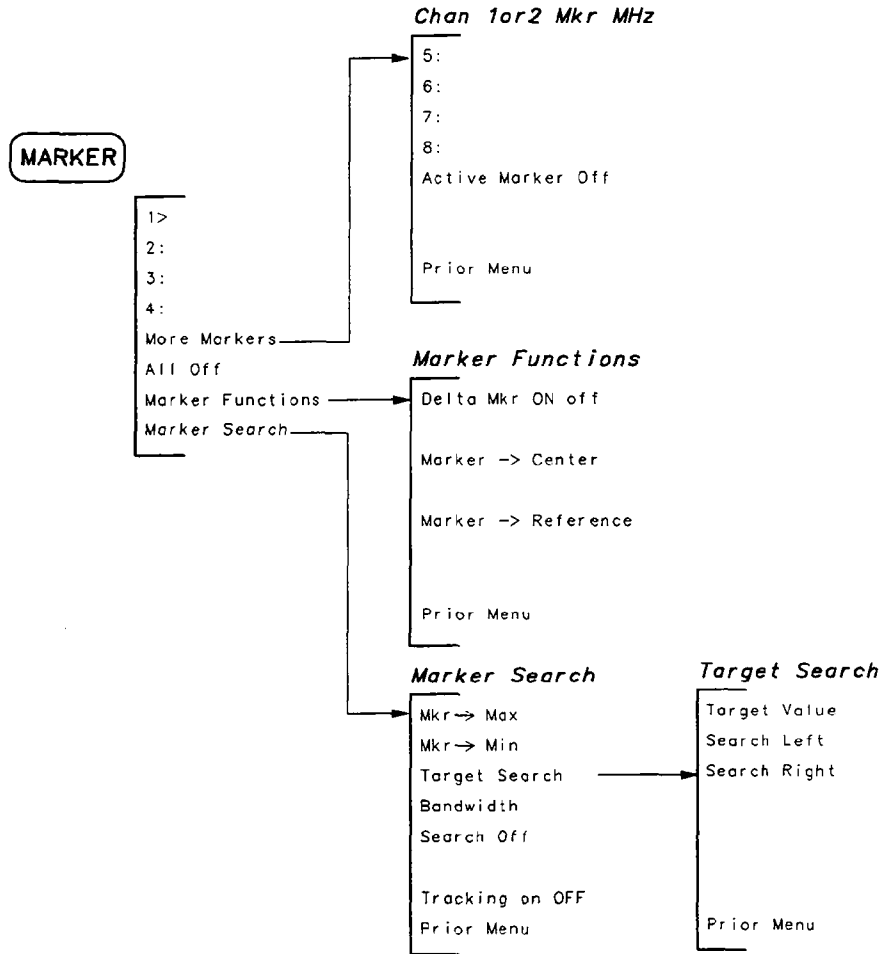

ad64a

Figure 7-8. Marker Menu

Marker: softkey in add max line, add min line, add max point, and add min point menus (see **DISPLAY**). Adds marker to data trace and allows it to be moved to identify trace frequencies and amplitudes. See also limin-line menu.

Marker -> Center: softkey in marker functions menu (see **MARKER**). Changes the center frequency to that of the active marker and modifies span accordingly. If markers are off, it first turns on marker #1 at its previous setting or at the center frequency (default).

Marker Functions: softkey in marker menu (see **MARKER**). Displays **Delta Mkr on OFF** softkey (see entry).

Marker -> Reference: softkey in marker functions menu (see **MARKER**). Makes reference level of graticule equal to marker value, does not change reference *position*. If markers are off, it first turns on marker #1 at its previous setting or the center frequency (default).

Marker Search: softkey in marker menu (see **MARKER**). Displays marker search menu to set active marker to maximum or minimum point or user defined target value. Also presents bandwidth search function (see **Bandwidth**).

MEAS: front panel area with **CHAN 1** and **CHAN 2** hardkeys. Allows choice of type of measurement and detection. See **CHAN 1**, measurement menu, detection options. Shown in Figure 1-2.

measurement calibration: a process that improves measurement accuracy by correcting systematic measurement errors. The network analyzer supports three types of calibration. 1. Default calibration: resident full frequency span cal of 401 points, stored in non-volatile memory. 2. Full band calibration: user-performed full frequency span cal of 801 points, good for calibrating systems with attenuators, filters, amplifiers, etc. in the measurement path. 3. User defined calibration: user sets frequency span, number of points, spur avoid setting, system bandwidth and performs cal, good for measurements of electrically long devices and narrow frequency spans. Note: when either full band cal or user defined cal is on and another cal is selected, the original is lost. Cals remain on until replaced by another cal or invalidated by changing measurement settings as noted on screen. See also spur avoid menu, "Measurement Calibration" in Chapter 8.

measurement menu: selected by **CHAN 1** or **CHAN 2** hardkeys. Allows selection of type of measurement and detection options with the softkeys illustrated below. For examples of transmission, reflection, power, and conversion measurements, see "Measuring Devices with an HP 8711A Network Analyzer" in Chapter 4.

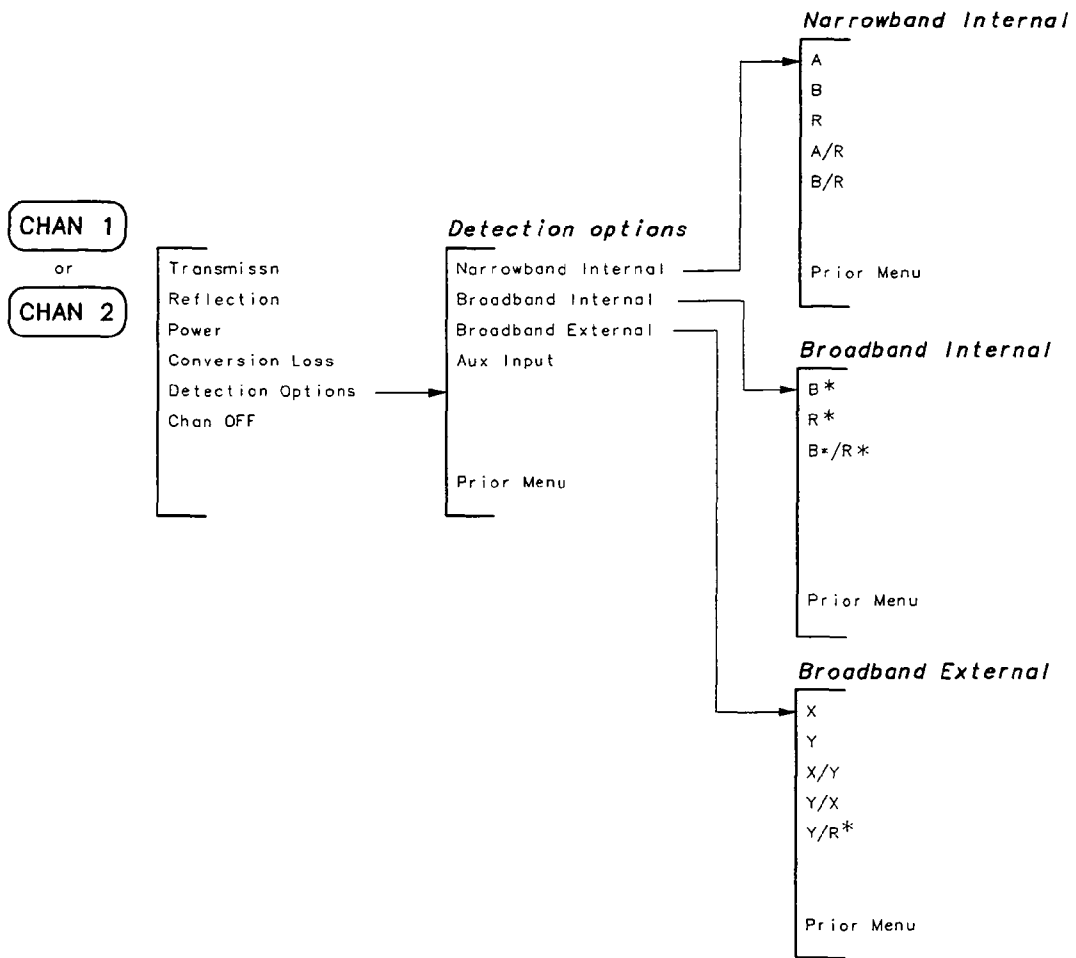

ad67a

Figure 7-9. Measurement Menu

measurement paths: the internal paths that various measurements (or detection options) take through the instrument.

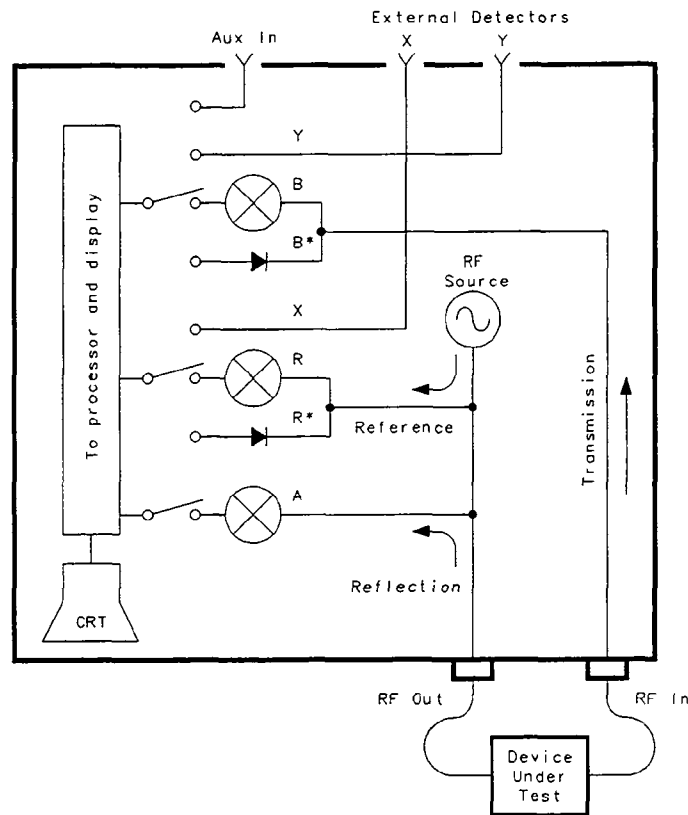

ad62c

Figure 7-10. Simplified Internal Instrument Measurement Paths

Medium: softkey in the system bandwidth menu (see average menu). In this mode, data traces tend to be relatively fast but somewhat noisy. Approximate bandwidth is 750 Hz. *See also system bandwidth.*

Memory: softkey (see **DISPLAY**). Displays the trace memory of the active channel, using the current display format, scale, and reference. **Note:** trace data must have been saved in memory previously with **Data→Mem**.

Memory 1: softkey in set pen numbers menu (see **HARDCOPY**). Sets pen number assignment (color) for memory trace 1 on hardcopy.

Memory 2: softkey in set pen numbers menu (see **HARDCOPY**). Sets pen number assignment (color) for memory trace 2 on hardcopy.

Memory Size: softkey in utilities menu (see **SYSTEM OPTIONS**) of instruments with IBASIC option. Enables user to change amount of memory allocated for IBASIC programs. Default is 8K bytes. For details, see *HP Instrument BASIC User's Handbook*.

menu: a list of choices shown on the network analyzer screen. The choices are labeled next to the softkeys. Each choice either displays another menu or performs an immediate action.

MENU: hardkey in the SOURCE area (see source menu). Displays menu with source setting selections: trigger functions, spur avoid features, etc.

menu map: diagram of hardkey and softkey structure, arranged by menus. An overall menu map is part of this chapter. See individual hardkey entry for its menus. *See also* the “Quick Reference Card.”

messages: on-screen information about instrument activity or status, or error state, self-explanatory, not documented elsewhere. In case of difficulty, refer to the Service Manual.

MHz: softkey in display frequency resolution menu (see frequency menu). Displays frequency to MHz resolution. For example, 1.234 567 MHz is displayed as 1 MHz (note rounding down). *See also* **Disp Freq Resolution**.

mixer: device that generates output frequencies equal to the sum and difference of two input frequencies. In brief, output frequency differs from input frequencies. For measurement examples, see “To Make a Conversion Loss Measurement” in Chapter 4.

Mixer: softkey (see **BEGIN**). Displays menu with selections suitable for mixer and frequency converter measurements: conversion loss, reflection. For measurement examples, see “To Make a Conversion Loss Measurement” in Chapter 4. *See* **conversion loss** and **reflection**.

Mkr ->Max: softkey in marker search menu (see **MARKER**). Places active marker at frequency point of maximum amplitude. If tracking is off, marker remains at that frequency. If tracking is on, marker moves to the maximum point with each sweep.

Mkr ->Min: softkey in marker search menu (see **MARKER**). Places active marker at frequency point of minimum amplitude. If tracking is off, marker remains at that frequency. If tracking is on, marker moves to the minimum point with each sweep.

Mkr Symbol ON off: softkey in define graph menu (see **HARDCOPY**). When on (default setting), prints or plots marker symbols when **Graph and Mkr Table** or **Graph Only** is selected.

Mkr Table Only: softkey in define hardcopy menu (see **HARDCOPY**). Defines hardcopy as a table of marker values (frequency and amplitude).

MM-DD-YYYY HH:MM: softkey in clock format menu. Formats the real-time internal clock to display time as Month-Day-Year Hour:Minute. *See also* **Clock Format**.

Monochrome: softkey in define printer and define plotter menus (see **HARDCOPY**). Toggles with **Color** to define printer or plotter as one color (black and white) or multi-color.

Monochrome Pen: softkey in set pen numbers menu (see **HARDCOPY**). Sets pen number assignment for hardcopy in monochrome plot mode.

More Display: softkey in display menu (see **DISPLAY**). Displays the more display menu to set split display, title and clock, Y-axis labeling, and graticule.

More Markers: softkey in marker menu (see **MARKER**). Displays menu with markers 5 through 8 and active marker off key.

More Printer: softkey in define printer menu (see **HARDCOPY**). Displays menu to set printer resolution, margins, and width.

N **Narrow**: softkey in the system bandwidth menu (see average menu). In this mode sweeps tend to be clean (not noisy) but slow. Approximate bandwidth is 250 Hz. *See also* **system bandwidth**.

narrowband: tuned receiver type measurement mode featuring wide dynamic range, intended for linear transmission and reflection measurements. *See also* **broadband**.

Narrowband Internal: softkey in the detection options menu (see measurement menu). Selects tuned receiver type measurements of inputs A, B, or R or the ratios A/R or B/R.

Next Screen: softkey which, when selected, displays the next screen or page in a series.

No: softkey in delete limit menu (see **DISPLAY**). Prevents deletion of the highlighted limit line in the limit-line table.

None: only in network analyzers with IBASIC option, softkey in IBASIC display menu (see **SYSTEM OPTIONS**). Displays the measurement data on the full screen. *See also* **Upper**. For details, see *HP Instrument BASIC User's Handbook*.

non-volatile memory: in the network analyzer, SRAM, used as RAM disk. It is backed up by +13V from power supply when network

analyzer is connected to line voltage; backed up by a battery when network analyzer is disconnected from line voltage. For examples of its use and limitations, see Appendix C at the end of this chapter.

Normalize: softkey in display and calibration menus (see calibration menu). Equivalent to selecting **Data->Mem** and **Data/Mem**. Corrects frequency response errors only. The only type of measurement “calibration” for power or conversion loss measurements. Note: this type of “calibration” is not interpolated: changes in frequency or number of points invalidate it. For an example, see “Improving Accuracy by Making a Normalization Calibration” in Chapter 4. For theory of measurement calibration, see Chapter 8.

Number of Points: softkey in source menu (see source menu). Selects the number of measurement points in a sweep: 51, 101, **201** (default), 401, 801, or 1601. As number of points increases, frequency resolution increases and sweep speed decreases.

Numeric: softkey in clock format menu. Formats the real-time internal clock to display the number of the month (for example, 03 for March). See also **Clock Format**.

- O ON|Standby switch**: located on left side of front panel. Turns on line power to the instrument.

Operating Parameters: softkey in system options menu (see **SYSTEM OPTIONS**). Displays four screens of channel settings, cal kit definitions, instrument settings, and instrument configuration.

overall menu map: chart of hardkey and softkey structure, arranged by menus.

Note



The *HP 8711A RF Network Analyzer Quick Reference Card* is a handy menu map which lacks only the service keys.

- P PARALLEL PORT**: connector on rear panel for use with peripherals with parallel interface. Pin-out is standard Centronics DB-25: all pins ESD protected, data and strobe pins have 2200 pF capacitors, voltage levels are TTL compatible, output pins can source 15 mA and sink 24 mA. Location shown in Figure 1-3.

Perform Secure: softkey in secure menu of instruments with IBASIC option. Use with caution: secured program lines can not be listed, seen, or edited; for details see *HP Instrument BASIC User's Handbook*.

pfr couplings: parameter-format-response couplings; one of several groups of measurement parameters (types) that share format and

response settings. For ease of use and memory conservation, the analyzer stores the format setting for each measurement parameter group. The format choices are log mag, lin mag and SWR. For example, if log mag format is initially selected for transmission measurements, the analyzer resets format to log mag when transmission is selected again. Additionally, the analyzer stores “response” settings (scale/div, reference level, reference position) for each format. For example, if log format is initially set at 5 dB/div and a reference level of 10 dB, the analyzer resets scale and reference level to 5 and 10 respectively when log format is selected again. The analyzer stores separate format and response settings for each channel.

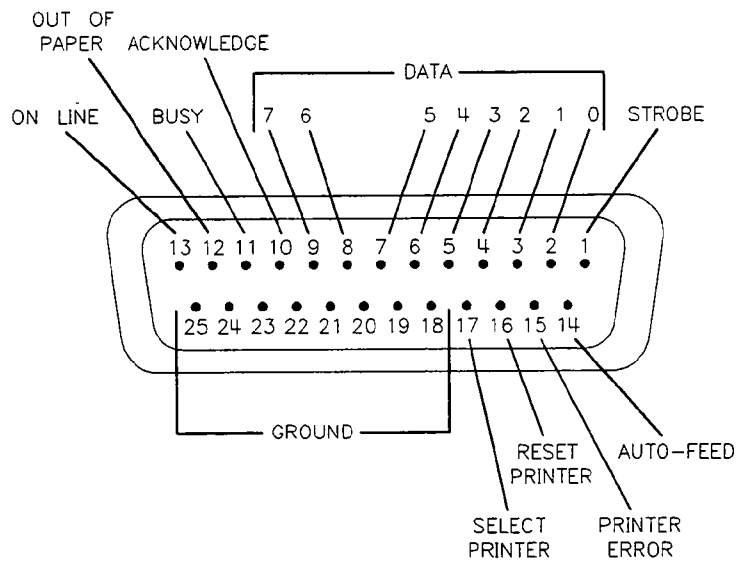

ad634a

Figure 7-11. Parallel Port Pinouts

Portrait: softkey in define printer menu (see **HARDCOPY**). Sets printer to print hardcopy so that paper is oriented with shorter edge at top and longer edges at sides. Default setting, toggles with **Landscape**.

Power: softkey in amplifier and measurement menus, suitable for power measurements. 1. Amplifier menu settings: detection option broadband internal transmission B*, frequency span 10 MHz to 1300 MHz, measurement calibration off (normalization is optional), log magnitude format, autoscale, marker to max, tracking off, medium system bandwidth. 2. Measurement menu settings: frequency span 0.3 to 1300 MHz, measurement calibration off (normalization is optional), log magnitude format, 10 dB/ division scale, reference at 0.0 dB, medium system bandwidth. For examples of measurements, see “To Make a Power Measurement” in Chapter 4.

POWER: hardkey in source area. Sets the power level of the internal RF source and turns it on and off. See also **Level**.

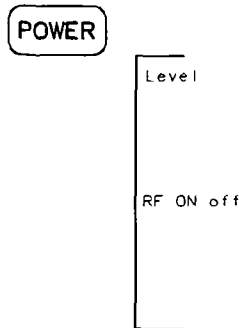

od635a

Figure 7-12. Power Menu

power cord receptacle: on the rear panel. Is fused and contains a spare fuse (fuse size is noted above the receptacle and in the “Replaceable Parts” chapter of the *HP 8711A RF Network Analyzer Service Manual*. Location shown in Figure 1-3.

power-up: action of turning on the network analyzer, applying line power to it. Power-up configures the network analyzer to the last used instrument state operating parameters. See also **PRESET**.

power supply LEDs: on rear panel, lower right, indicate the status of the power supply.

| Line Switch | LEDs | | Status |
|-------------|----------------|-----|-----------------------------------|
| | Green | Red | |
| 1 (ON) | ON | OFF | Normal |
| 0 (STBY) | ON | ON | Normal |
| 1 OR 0 | OFF | OFF | Replace fuse |
| | OTHER/BLINKING | | Unplug line cord and call service |

Printer Resolution: softkey in more printer menu (see **HARDCOPY**). Sets printer resolution in terms of dots per inch. Check printer manual for appropriate setting. Default is 96 dots per inch.

Prior Menu: softkey which displays the previous menu.

Print Width: softkey in more printer menu (see **HARDCOPY**). Sets print width (printing space) in mm (25.4 mm = 1.00 inches). Minimum setting is 80 mm; default is 150.00 mm (5.91 inches);

maximum is 500 mm. Width is defined relative to the printer. It is the dimension at right angle to the travel of the paper. Landscape mode is rotated one-quarter turn relative to portrait mode. Thus in landscape mode “width” defines “height,” the top and bottom parameters.

PRESET: hardkey on front panel, returns network analyzer to predefined instrument state. Does not perform self-test. For details, see Appendix A at the end of this chapter.

Previous Screen: softkey which, when selected, displays the previous screen or page in a series.

PROBE POWER: connector on front panel. Provides fused power (–12.6 VDC at 150 mA nominal, +15 VDC at 200 mA nominal, GND) for active probes and other devices (shown in Figure 1-2).

Programs: softkey in save recall menu (see entry). Displays menu to save, re-save, recall programs, or save a program as an autostart (AUTOST) program. For details, see *HP Instrument BASIC User's Handbook*.

Q *Quick Reference Card*: handy pocket-size reference showing menu structure with pertinent tips; two supplied with instrument.

R **R**: softkey in narrowband internal menu (see measurement menu). Selects tuned receiver type of measurement of input R (reference signal).

R*: softkey in broadband internal menu (see measurement menu). Selects diode detection type measurement of input R* (broadband internal reference signal).

Recall Program: softkey in programs menu (see **SAVE RECALL**). Recalls to the network analyzer a program from internal memory, internal disk, or external disk (see **Select Disk**). For details, see *HP Instrument BASIC User's Handbook*.

Recall State: softkey (see **SAVE RECALL**). Recalls to the screen *state* files (not plot files) from internal memory, internal disk, or external disk (see **Select Disk**). The information recalled is defined by **Define Save**.

recognized HP-IB address: the HP-IB address that the network analyzer has assigned to a specific instrument or device. For proper communication and control, the recognized and actual HP-IB address must match. *See also* HP-IB, actual HP-IB address.

R

red LED: on rear panel, lower right, off in normal operation. *See also* power supply LEDs.

Ref: value of reference line, denoted by triangle at left of graticule. The annotation appears at the top line of the screen; default is 0 dB.

Reference Level: softkey (see **SCALE**). Sets the value of the reference line. The reference value is noted on the screen as “Ref”. Default is 0 dB, max is 99 dB, min is -99 dB.

reference line: horizontal line of known value on graticule. The value is shown on the top line of the screen as “Ref.” The line is indicated by a small triangle at the left edge of the graticule.

Reference Position: softkey (see **SCALE**). Sets the position of the reference line from the top of the graticule (10) to the bottom (0) or in between. Default position is middle (5).

reflection: type of measurement, the amount of power reflected by the device under test back to the RF OUT port (or an external detector) relative to the applied power.

Reflection: softkey in amplifier, filter, broadband passive, mixer, measurement, and calibration menus. Selects forward reflection type of measurement. Power is output from the RF OUT port and also measured there. 1. Amplifier, filter, broadband passive, and mixer menu settings: detection option narrowband internal A/R, frequency span 0.3 to 1300 MHz, default reflection calibration, log magnitude format, autoscale, marker to min, tracking off, medium system bandwidth. 2. Measurement menu settings: frequency span 0.3 to 1300 MHz, default reflection calibration, log magnitude format, 10 dB/ division scale, reference at 0.0 dB, medium system bandwidth. 3. In calibration menu, displays reflection cal menu. For examples of measurements, see “To Make a Reflection Measurement” in Chapter 4. For theory, see “Measurement Calibration” in Chapter 8.

reflection cal menu: part of calibration menu, allows selection of type of reflection calibration: default, full band, or user defined.

REFLECTION RF OUT: front panel port, outputs the RF signal and also serves as input for reflection measurements. Type-N female connector. For location see Figure 1-2, for pin recession limits see Figure 1-7.

register: internal non-volatile memory available for saving instrument states, in this network analyzer referred to as a file name for saving to or recalling from disk.

relative measurements: 1. Fundamental type of network analyzer measurement, a ratio such as A/R, B/R, X/Y, etc. 2. Display mode wherein graticule values are shown relative to reference line. *See also* **Y-axis Lbl rel ABS**.

Remove Directory: softkey in directory utilities menu (see **SAVE RECALL**). First highlight the intended directory, then press **Remove Directory**. Deletes empty directories only.

Rename File: softkey in file utilities menu (see **SAVE RECALL**). Displays character entry menu to rename the highlighted file.

Re-Save Program: softkey in programs menu (see **SAVE RECALL**). Displays character entry menu to re-title program and save it to memory or disk. *See also* character entry menu. For details of programming, see *HP Instrument BASIC User's Handbook*.

Re-Save State: softkey (see **SAVE RECALL**). Displays character entry menu to re-title file and save it to memory or disk. *See also* character entry menu.

Restart Average: softkey (see average menu). Clears the running average and restarts it with the next sweep.

Restore Defaults: softkey in several menus. 1. In transmission and reflection calibration menus (see calibration menu), the default measurement calibration becomes the active calibration. This cal is originally performed and stored in non-volatile memory at the factory by performing an adjustment test. It is a full frequency span cal of 401 points. When selected, it erases a full band or user defined cal, if any. *See also* measurement calibration. 2. In several hardcopy menus (see **HARDCOPY**), resets addresses, baud rates, handshakes, color, pens, resolution, margins, etc. to predetermined values. Note: this key restores values of all features below it, including those in lower level menus. 3. In external CRT adjustment menu, restores CRT timing values.

RF ON off: softkey (see **POWER**). Turns the internal RF source off and on. Default is ON. *See also* **Detector Zero**.

Round Seconds: softkey in set clock menu (see **SYSTEM OPTIONS**). Rounds off seconds to nearest minute. Rounds down with less than 30 seconds; rounds up to next minute with more than 30 seconds.

RS-232: connector on rear panel for printers or plotters with serial interfaces. Location shown in Figure 1-3.

S

Run: only in network analyzers with IBASIC option, softkey in IBASIC menu (see **SYSTEM OPTIONS**). When a program is ready to run, this softkey allows it to do so. See also *HP Instrument BASIC User's Handbook*.

S save: to store data in memory or disk for later recall. For memory usage examples and limitations, see Appendix C at the end of this chapter.

Save ASCII: softkey in define save menu (see **SAVE RECALL**). Selects the channel (1 or 2) whose trace data is to be saved in ASCII format for output. Can be used with spreadsheets. Note: the destination memory or disk is set by **Select Disk**.

Save AUTOST: softkey in programs menu (see **SAVE RECALL**). Titles the current program AUTOST and saves it to memory or disk as set by **Select Disk**. At power-up, the network analyzer searches the internal disk for an AUTOST (auto-start) file, loads it, and executes it if present.

Save Program: softkey in programs menu (see **SAVE RECALL**). Saves the current program to memory or disk as set by **Select Disk**. For details, see *HP Instrument BASIC User's Handbook*.

Save State: softkey (see **SAVE RECALL**). Saves information to memory or disk as set by **Select Disk**; automatically names file "STATE#." See also **Re-Save State**. **Define Save** selects the information.

save recall screen: screen displayed by network analyzer to facilitate saving and recalling information; press **SAVE RECALL** to display. The screen consists of four or more lines as shown below.

| | | | |
|------------|----------|---------------|---------------|
| DOS volume | 8711_MEM | Date and Time | Page 1/1 |
| MEM:\ | | Bytes Free: | |
| FILENAME | TYPE | SIZE | LAST CHANGE |
| ..<PARENT> | <DIR> | | |
| STATEO.STA | BDAT | 3840 | Date and Time |

ad636a

Figure 7-13. Save Recall Screen Annotations

Top Line:

DOS (or LIF): format of the disk

Date and Time: current date and time as set in set clock menu

Page 1/1: current and total pages of file list

Second Line:

MEM:\ (or INT:\ or EXT:\): current memory selection, nonvolatile MEMory, INTernal disk, or EXTernal disk. It is followed by the parent directory name.

Bytes Free: amount of memory space available in bytes. *See also* Appendix C in this chapter.

Third Line (column heads):

FILE NAME: name of directory or filename.

TYPE: directory or file.

SIZE: in bytes.

LAST CHANGE: when the directory was created or the file saved.

SAVE RECALL: hardkey in SYSTEM area of front panel. Displays menus to save, title, define, and recall states and programs; rename, delete, and copy files; and select, configure, and format disks. See “Saving and Recalling Measurement Results” in Chapter 5 for examples.

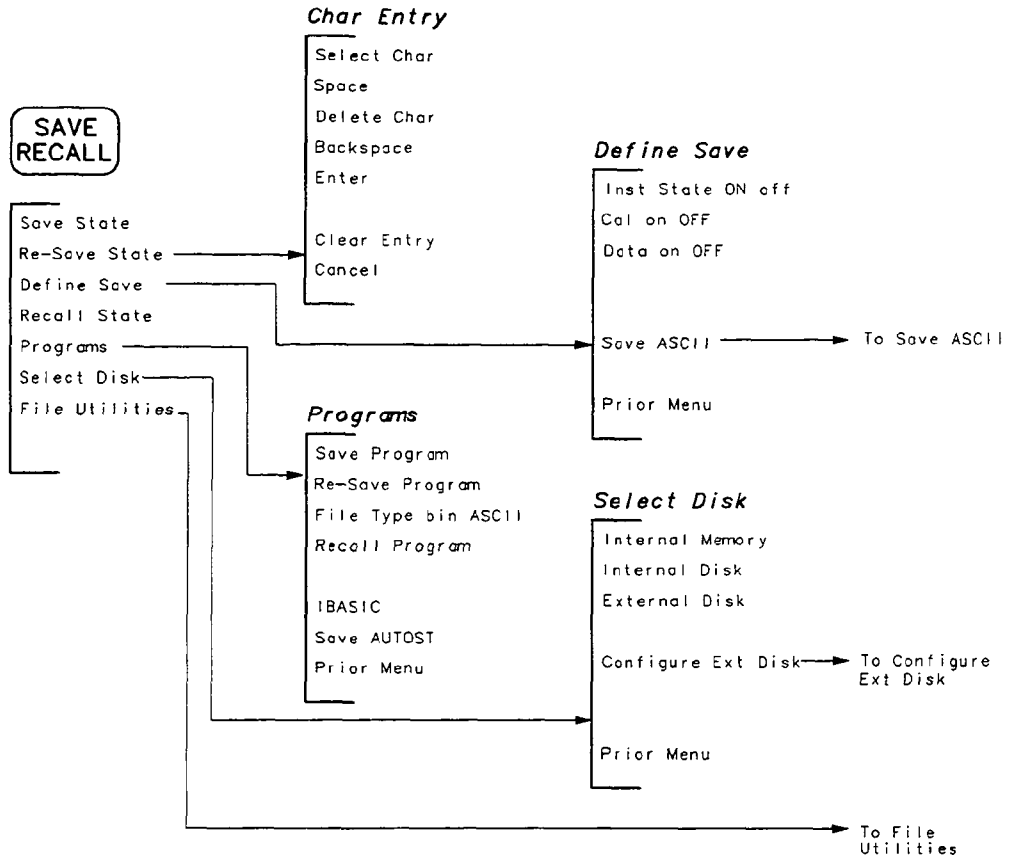

ad637a

Figure 7-14. Save Recall Menu (1 of 2)

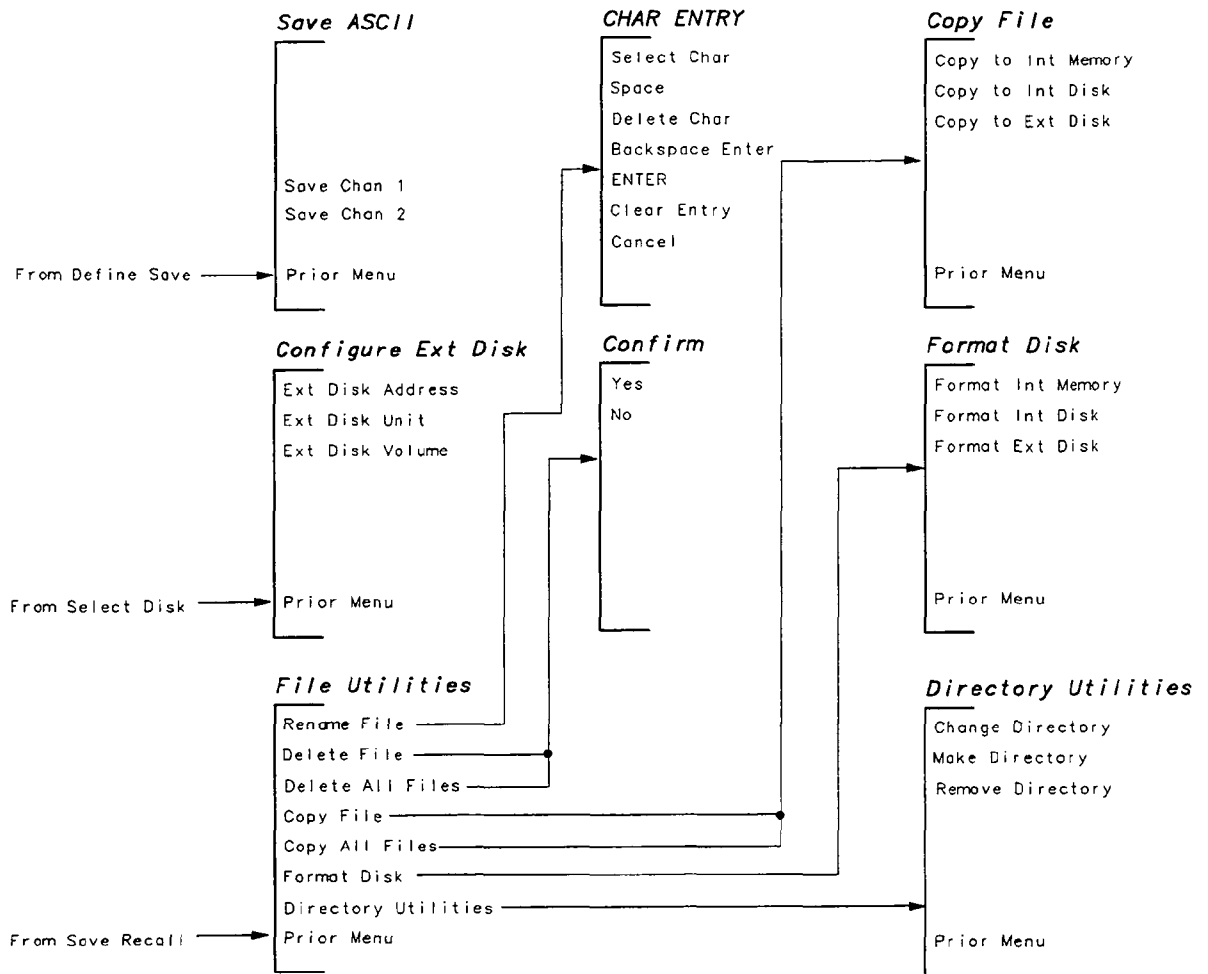

ad638a

Figure 7-15. Save Recall Menu (2 of 2)

SCALE: hardkey in CONFIGURE area of front panel. Displays the menu below.

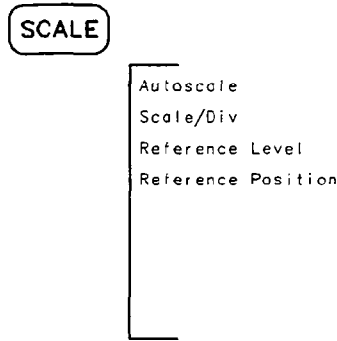

dd610a

Figure 7-15. Scale Menu

Scale/Div: softkey (see **SCALE**). Sets value of vertical divisions of graticule. If scale/div is 10 dB, each graticule line is 10 dB higher than the one below.

screen annotations: words, symbols, and messages that appear on the CRT.

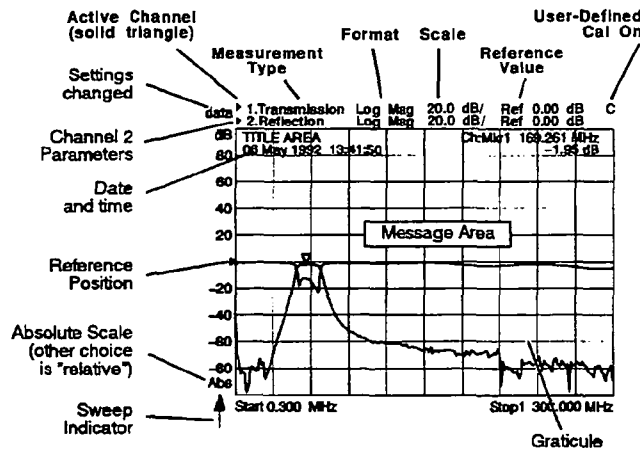

Figure 7-16. Screen Annotations

Search Left: softkey in target search menu (see **MARKER**). Moves active marker leftward (lower frequency) to the first occurrence on the data trace where the amplitude equals the target value. That first occurrence may be an actual data point or an interpolated value. For examples of use, see "To Search for Specific Values on the Measurement Trace" in Chapter 5.

Search Off: softkey in marker search menu (see **MARKER**). With tracking on, disables searching for maximum, minimum, target value, or bandwidth.

Search Right: softkey in target search menu (see **MARKER**). Moves active marker rightward (higher frequency) to the first occurrence on the data trace where the amplitude equals the target value. That first occurrence may be an actual data point or an interpolated value. For examples of use, see “To Search for Specific Values on the Measurement Trace” in Chapter 5.

Seconds ON off: softkey in clock format menu (see **SYSTEM OPTIONS**). Toggles on and off the seconds annotation that is displayed or printed as part of the clock. *See also* **Clock Format**.

Secure: softkey in utilities menu (see **SYSTEM OPTIONS**) of instruments with IBASIC option. Enables user to define part or all of a program by start and end lines. Once secured, the defined lines can not be listed, seen, or edited. For details, see *HP Instrument BASIC User's Handbook*.

Select: softkey in select copy port menu (see **HARDCOPY**). Selects the hardcopy port device highlighted in the select copy port list.

Select Char: softkey in character entry menu (see **DISPLAY** or **SAVE RECALL**). Adds character selected by pointer to end of title.

Select Copy Port: softkey (see **HARDCOPY**). Displays menu to select hardcopy device and its operating parameters. Default settings (not affected by preset) are HP printer, PCL language, parallel port. Use knob or arrow keys to highlight device, then press **Select**. Note: “Hardcopy Address” applies only to HP-IB devices; “Baud Rate,” “Xon/Xoff,” and “DTR/DSR” apply only to serial devices.

Select Disk: softkey (see **SAVE RECALL**). Displays menu to select type of disk or memory location to save to or recall from: internal memory, internal disk, and external disk. Also allows configuration of external disk.

self-test: a series of internal CPU tests performed by the network analyzer at power-up. For details, refer to the Service Manual.

Service: softkey (see **SYSTEM OPTIONS**). Displays menus related to service, including displaying instrument information (see **Instrument Info**). Detailed information on the service menus is in the *HP 8711A RF Network Analyzer Service Manual*.

Service Utilities: softkey in service menu (see **SYSTEM OPTIONS**). Displays menu of service functions. For details, see the Service Manual.

Set Clock: softkey in system configure menu (see **SYSTEM OPTIONS**). Displays menu to set real-time internal clock of network analyzer and its format. To set year, month, day, hour, or minute, press the softkey, enter a number, and press **Enter**. Pressing **Round Seconds** rounds off the seconds to the nearest minute. To display clock on screen, press **DISPLAY** **More Display Title and Clock Show Clock on Line...**. To not print or plot clock, use **Title + Clk** key in **HARDCOPY** menu. To change format, see **Clock Format**.

Set Day: softkey in set clock menu (see **SYSTEM OPTIONS**), sets day of month. To use this key, see **Set Clock**.

Set Hour: softkey in set clock menu (see **SYSTEM OPTIONS**). To use this key, see **Set Clock**.

Set Minute: softkey in set clock menu (see **SYSTEM OPTIONS**). To use this key, see **Set Clock**.

Set Month: softkey in set clock menu (see **SYSTEM OPTIONS**). To use this key, see **Set Clock**.

Set Pen Numbers: softkey in define plotter menu (see **HARDCOPY**). Displays set pen numbers menu to assign pen numbers to items to be plotted (like traces, graticule, etc.). In color setting (see **Color**), different items can be plotted with different pens. In monochrome setting, all items are printed with the same pen. Note: the pens can be a combination of colors or widths.

Set Year: softkey in set clock menu (see **SYSTEM OPTIONS**). To use this key, see **Set Clock**.

Show Clock on Line 1: softkey in title and clock menu (see **DISPLAY**). Displays the clock on the uppermost line of the title area when **Title+Clk ON off** is on.

Show Clock on Line 2: softkey in title and clock menu (see **DISPLAY**). Displays the clock on the second line of the title area when **Title+Clk ON off** is on.

Single: softkey in trigger menu (see source menu). Immediately stops the current sweep, takes one complete sweep, and holds until retriggered. See also **Trigger**.

Softkey: one of eight unlabeled keys along the right side of the CRT. Performs the named function or displays the next menu. Typographic convention: Upper And Lower, Shaded. See also **HARDKEY**. For location, see Figure 1-2.

SOURCE: front panel area with four hardkeys that control the source frequency, sweep, power, and trigger. For location, see Figure 1-2.

source: in the network analyzer, a frequency synthesized swept RF signal generator.

source menu: displayed by the source area **MENU** hardkey. Displays menu with source setting selections: trigger, number of frequency points, external frequency reference, and spur avoid.

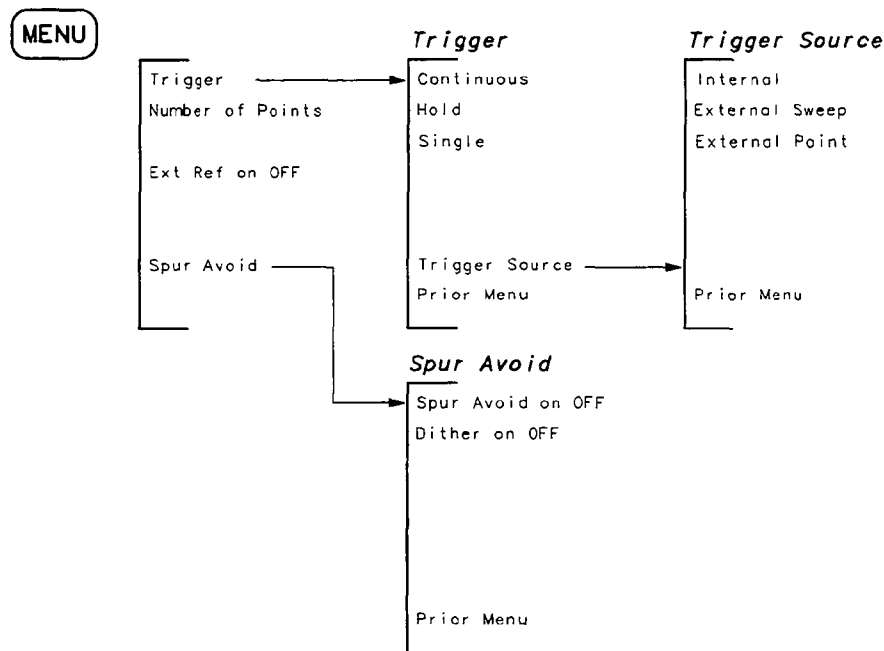

ad639a

Figure 7-17. Source Menu

Space: softkey in character entry menu (see **DISPLAY** or **SAVE RECALL**). Adds blank space to title.

Span: softkey (see frequency menu). Selects frequency span of source. When selected, it changes the stop frequency annotation to span and start to center.

Split: softkey in split display menu (see **DISPLAY**). In split display, the CRT display is split into two halves to show one measurement trace above the other. *See also Split Display.*

Split Disp: softkey (see **DISPLAY**). Displays split display menu to choose full display (default) or split horizontal display. For example, see “To Display Different Characteristic Measurements” in Chapter 5.

spur: undesired signal generated by harmonics or mixing of existing desired signals or high frequency components of complex wave shapes.

Spur Avoid: softkey (see source menu). Displays menu for selection of spur avoidance and dither features. *See also spur avoid menu.*

spur avoid menu: offers two features to avoid frequency dependent spurs found in low-level measurements in narrowband mode; does not affect broadband internal or external measurements. 1. Dither moves the frequency of the spur but does not change the RF output frequency. Dither shifts frequencies internal to the instrument that mix to give the RF output frequency. It is recommended for narrow frequency spans that show a spur. Dither does not increase sweep time. If this function does not produce the desired effect, use **Spur Avoid**. For best accuracy: set dither on and then perform a user defined cal. Turning dither off after calibration invalidates the cal. 2. Spur avoid works by sweeping to a point before the spur, stopping the sweep, shifting the spur by shifting frequencies internal to the instrument, sweeping through the spur location, then shifting back and continuing the sweep. It determines which spurs need to be avoided with an algorithm based on frequencies, number of points, sweep time, and system bandwidth. It does not change the RF output frequency. It is recommended for measurements where dither does not produce the desired effect. Spur avoid increases sweep time by an amount dependent on the above instrument parameters. For best accuracy: set spur avoid on and then perform a user defined cal. Turning spur avoid off after calibration invalidates the cal. *See also measurement calibration.*

Spur Avoid on OFF: softkey (see source menu). Suitable for narrowband internal measurements which may show spurs. Selects a spur avoidance algorithm which avoids spurs by dithering around them as required. To compare this feature with dither, see spur avoid menu, above.

standby|on switch: located on left side of front panel. Toggles the instrument between its on and standby states. In standby, only the power supply (and the two rear panel LEDs) are on. For location, see Figure 1-2. *See also LEDs.*

Start: softkey in two menus. 1. In frequency menu (see entry), sets start frequency of source. Minimum frequency is 300 kHz. When start is selected, the other frequency parameter is stop. 2. In hardcopy menu (see **HARDCOPY**), starts print or plot as set in select copy port menu. Channel number of trace is printed (although not visible on screen).

Start Line #: softkey in secure menu of instruments with IBASIC option. Not shown in this manual; for details see *HP Instrument BASIC User's Handbook*.

status notation: two symbols at the left side of the graticule which indicate the current status of the data trace. In normal operation, the up arrow and Data? are not on at the same time (except momentarily). When the network analyzer is sweeping, the up arrow is on or flashing. When the network analyzer is not sweeping (in hold mode), the up arrow is off. Data? indicates that the current data trace may not reflect the current instrument state. For example, if you place the network analyzer in hold and change the frequency setting, Data? appears: the trace no longer reflects the new frequency setting. As soon as you finish another sweep at the new setting, Data? disappears.

Step: only in network analyzers with IBASIC option, softkey in IBASIC menu (see **SYSTEM OPTIONS**). When a program is ready to run, this softkey steps through the program one line at a time. Good de-bugging tool. See also *HP Instrument BASIC User's Handbook*.

Stop: softkey (see frequency menu). Sets stop frequency of source, operates with **Start** to set measurement frequency span. Maximum frequency is 1.3 GHz. See also **Span**.

sweep: a measurement data trace. Or to take a data trace, to generate measurement data from the lowest to the highest frequency.

SWEEP: hardkey in SOURCE area of front panel. Displays menu to select automatic sweep time (fastest possible), manual setting, or alternate sweep. For examples of changing sweep time, see "Increasing Sweep Speed" in Chapter 6.

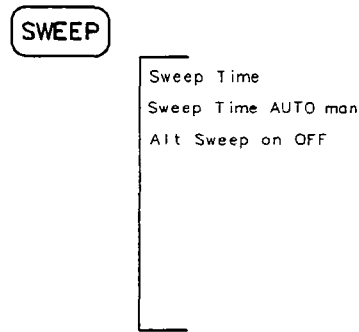

ad640a

Figure 7-18. Sweep Menu

Sweep Time: softkey (see **SWEEP**). Sets sweep time from fastest possible to three days, overrides auto sweep time.

Sweep Time AUTO man: softkey (see **SWEEP**). Sets the network analyzer to sweep as fast as possible (automatic) or at the sweep time of your choice (manual).

SWR: softkey in format menu (see **FORMAT**). Displays the data formatted as SWR (standing wave ratio).

SYSTEM: front panel area with four hardkeys to preset the instrument, control the disk drives, internal memory, printers and plotters, IBASIC, HP-IB, and service functions.

System Bandwidth: softkey in the system bandwidth menu (see average menu). Displays menu to set bandwidth of IF filters in receiver section of network analyzer, determines receiver selectivity. For example, see “Reducing Trace Noise” in Chapter 6; for theory, see “Noise Reduction” in Chapter 8.

| System BW | Dynamic Range | Sweep Speed | Approx BW |
|------------------|---------------|-------------|-----------|
| Wide | Low | Fast | 6500 Hz |
| Medium (default) | Medium | Medium | 750 Hz |
| Narrow | High | Slow | 250 Hz |

System Config: softkey in system options menu (see **SYSTEM OPTIONS**). Displays menu to adjust clock setting, set beeper volume, and adjust external CRT settings.

System Controller: softkey in HP-IB menu (see **SYSTEM OPTIONS**), makes the network analyzer the system controller of the HP instrument bus. Required mode for interfacing with HP-IB peripherals (printers, plotters, and disk drives). Also required by IBASIC to talk to HP-IB peripherals. This operation mode is not selectable with another active controller on the bus. For details on using the network analyzer with another controller on the bus see "Passing Control" in the "HP-IB Programming Guide." *See also Talker/Listener.*

SYSTEM OPTIONS: hardkey in system front panel group. Displays the following menus:

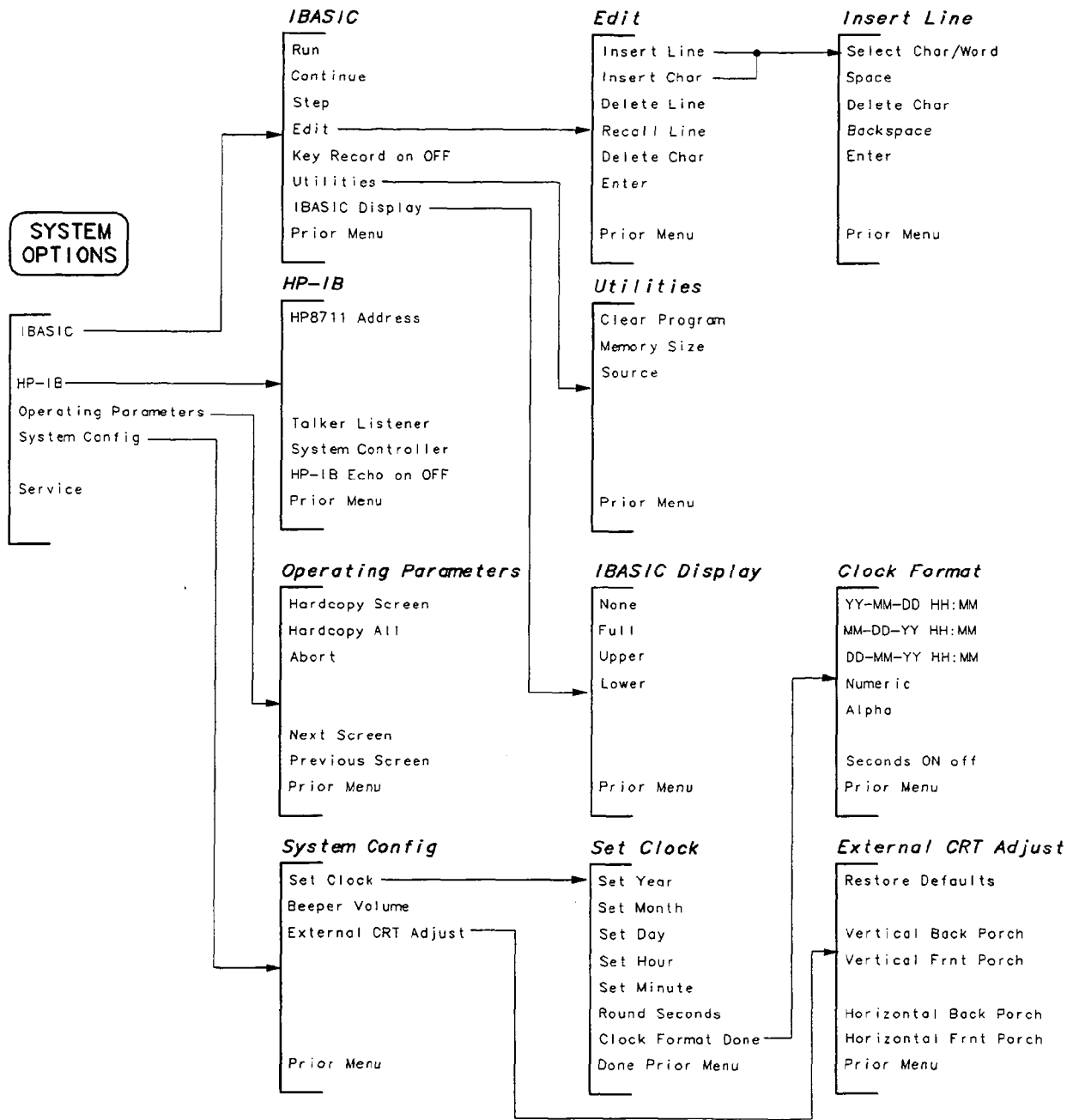

ac65a

Figure 7-19. System Options Menu

T talker: an HP-IB device which has been addressed to send data over the bus. There can be only one talker at a time.

Talker/Listener: softkey in HP-IB menu (see **SYSTEM OPTIONS**). HP-IB mode of network analyzer normally used for remote (computer) control of the network analyzer. The computer can designate the network analyzer as talker or listener. The network analyzer cannot talk directly with other peripherals unless the computer establishes a data path for it. *See also System Controller.*

Target Search: softkey in marker search menu (see **MARKER**). Displays menu to set target search value, search left, or search right.

Target Value: softkey in target search menu (see **MARKER**). Sets value of target sought by **Search Left** or **Search Right**. Default value is -3 dB. Identifies frequency of data point with specified value. Note: since markers are continuous but frequency points are discrete, target values may be interpolated. *See also marker.*

Tests and Adjustments: softkey in service menu (see **SYSTEM OPTIONS**). Displays menu to perform tests, including self-tests, and adjustments. Detailed information on the service menus is in the *HP 8711A RF Network Analyzer Service Manual*.

TEST RESULTS: seven-segment diagnostic LED visible inside rear panel at upper edge. In normal operation, it is off. For details see the service manual. In case of difficulty, see the service manual or call HP. Location shown in Figure 1-3.

time: to adjust internal clock of network analyzer, see **Set Clock**.

Title and Clock: softkey in more display menu (see **DISPLAY**). Displays menu to display and edit screen title and display clock.

Title+Clk ON off: softkey in title and clock menu (see **DISPLAY**) and define graph menu (see **HARDCOPY**). 1. In title and clock menu, toggles title (if any) and clock (if on) on and off. 2. In define graph menu, when on (default setting), prints or plots title (if any) and clock when **Graph and Mkr Table** or **Graph Only** is selected.

Top Margin: softkey in more printer menu (see **HARDCOPY**). Sets top margin (non-printing space) in mm (25.4 mm = 1.00 inches). Minimum setting is 0.00 mm (default); maximum setting is 200.00 mm.

trace: the graphical display of measured data on the CRT, also called measurement trace, data trace.

Trace 1: softkey in set pen numbers menu (see **HARDCOPY**). Sets pen number assignment for data trace 1 on hardcopy. Different pen numbers can represent different color or width pens. For an example of setting pen numbers, see “To Define the Hardcopy Device Settings” in Chapter 5.

Trace 2: softkey in set pen numbers menu (see **HARDCOPY**). As above, for data trace 2.

Trace Data ON off: softkey in define graph menu (see **HARDCOPY**). When on (default setting), prints or plots measurement trace data when **Graph and Mkr Table** or **Graph Only** is selected.

Tracking on OFF: softkey in marker search menu (see **MARKER**). When on, the marker to max, marker to min, bandwidth, and target search functions are updated with each trace. When off (default setting), the functions are performed only once, when selected.

transmission: type of measurement, in this network analyzer it is the ratio of power transmitted through the device under test to power incident to the device under test. Also, amount of power transmitted through the device under test. May be internal or external, broadband or narrowband.

transmission cal menu: part of calibration menu (see entry), allows selection of type of transmission calibration: default, full band, or user defined.

TRANSMISSION RF IN: front panel port. Receives the RF signal for internal transmission measurements. Type-N female connector. See Figure 1-7 for connector pin recession limits.

Transmissn: softkey in amplifier, filter, broadband passive, measurement, and calibration menus. Selects ratioed forward transmission type of measurement. Power is output from the RF OUT port and measured at the RF IN port. 1. Amplifier, filter, broadband passive, and mixer menu settings: detection option narrowband internal B/R, frequency span 0.3 to 1300 MHz, transmission measurement calibration, log magnitude format, autoscale, marker to max, tracking off, medium system bandwidth. 2. Measurement menu settings: frequency span 0.3 to 1300 MHz, default transmission measurement calibration, log magnitude format, 10 dB/ division scale, reference at 0.0 dB, medium system bandwidth. 3. In calibration menu, displays transmission cal menu. For examples of measurements, see “Measuring Devices with

an HP 8711A Network Analyzer” in Chapter 4. For theory, see “Measurement Calibration” in Chapter 8.

trigger: the stimulus that causes the network analyzer to begin a sweep. May be internal or external, automatic or manual.

Trigger: softkey (see source menu). Displays menu with choices for triggering the network analyzer. The network analyzer can be triggered continuously (default setting) or once. It can be triggered internally (default setting), externally, or externally one frequency point at a time.

Trigger Source: softkey in trigger menu (see source menu). Displays menu for choice of internal or external triggering. *See also Trigger.*

Type-N(m): softkey in cal kit menu (see **CAL**). Selects type of cal kit as type-N, male, where male refers to the center conductor sex of the test port.

U Unrecoverable error: an instrument state which prevents normal operation without user intervention. If this occurs, please record

- Process name
- Error number
- Additional operating information

Then cycle power.

Caution



The following procedure should be used as a last resort if cycling power does not clear the problem. It will clear SRAM, and erase the RAM disk, instrument state, saved states, calibrations, and peripheral settings.

- Cycle power again while repeatedly pressing **PRESET** (merely holding **PRESET** in is not effective).

Also known as system crash, deadlock, fatal error.

Update Corr Const: softkey in service menu (see **SYSTEM OPTIONS**). Displays a menu to store correction constants to disk or memory, or load them from disk. For details, see the Service Manual.

Upper: only in network analyzers with IBASIC option, softkey in IBASIC display menu (see **SYSTEM OPTIONS**). Displays the IBASIC program on the upper half of the screen and measurement data on the lower half. For details, see *HP Instrument BASIC User's Handbook*.

User Defined: softkey in transmission and reflection calibration menus (see calibration menu). The most adaptable type of measurement calibration: you set frequency span, number of points, spur avoid setting, system bandwidth. Its use is indicated by the letter C on the upper right corner of the screen. Useful for measurements of electrically long devices. You can reduce (but not increase) the frequency span after calibration if desired. When selected, it erases a full band cal, if any. When the default or full band cal is selected, this cal is erased. *See also* measurement calibration.

User Defined: softkey in cal kit menu (see **CAL**). Normally ghosted (inactive), allows selection of a user defined cal kit after a cal kit has been loaded into the analyzer. With this feature you can use any cal kit for which you can generate (or copy) a definition file. For an example of this procedure, see "To Calibrate with a User-Defined Cal Kit" in Chapter 6.

USER TTL IN/OUT: BNC connector on rear panel. Its signal is a bidirectional open-collector TTL signal which can be set and read using IBASIC. Can be used with foot switches or control relays for automation. Location shown in Figure 1-3.

Utilities: softkey in IBASIC menu (see **SYSTEM OPTIONS**). Enables user to clear program, set memory size, or secure programs (see entries or *HP Instrument BASIC User's Handbook* for details).

V Vertical Back Porch: softkey in external CRT adjustment menu (see **SYSTEM OPTIONS**). CRT timing adjustment for use with external monitors. Also affects network analyzer's internal CRT. Default setting is 622.8 usec. *See also* **VIDEO OUT**.

Vertical Frnt Porch: softkey in external CRT adjustment menu (see **SYSTEM OPTIONS**). CRT timing adjustment for use with external monitors. Also affects network analyzer's internal CRT. Default setting is 16.6 msec. *See also* **VIDEO OUT**.

VIDEO OUT: BNC connector on rear panel. Provides an RS-343A compatible monochromatic signal for an external multi-sync monitor (not EGA or VGA). If the external monitor does not operate properly, refer to its manual for timing requirements. Location shown in Figure 1-3.

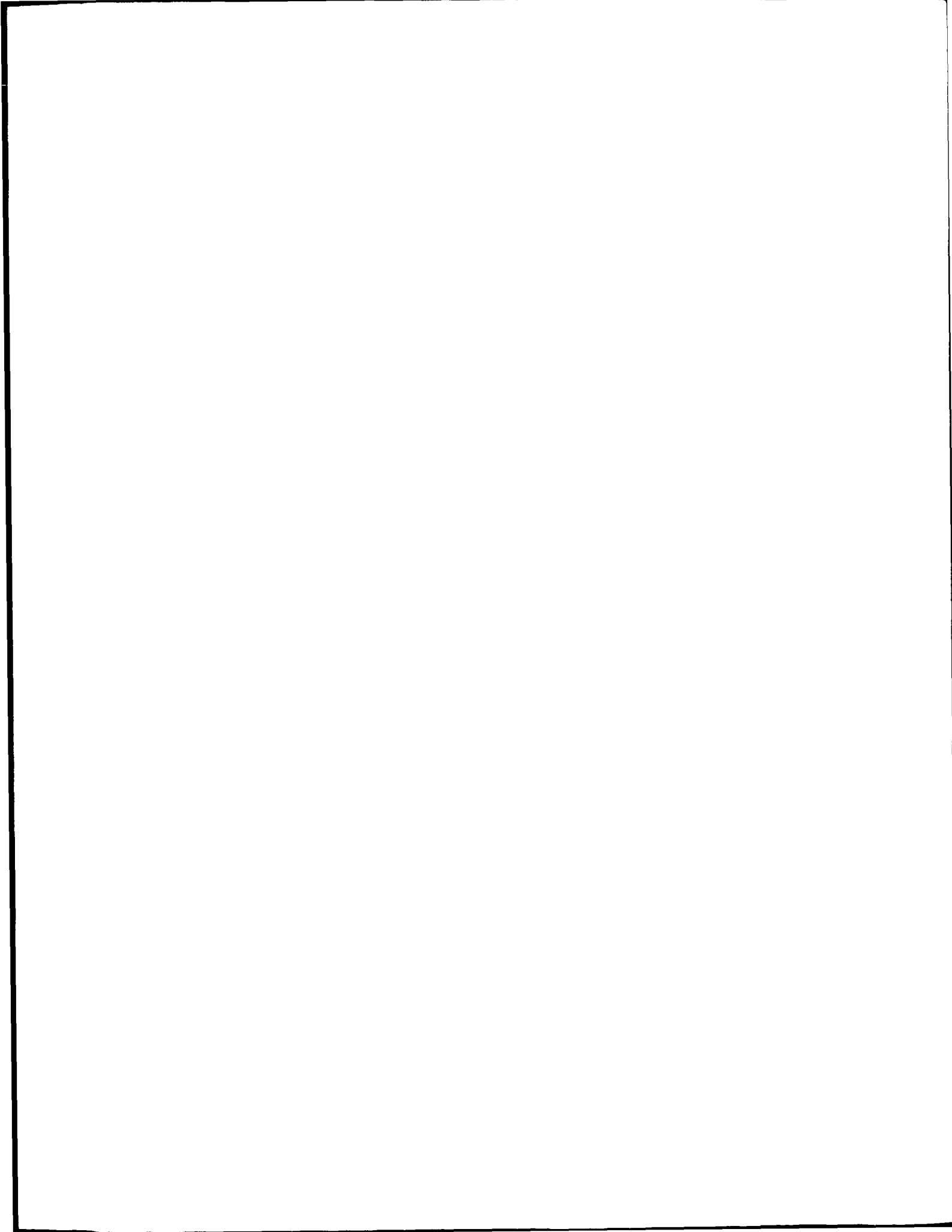

W **Wide**: softkey in the system bandwidth menu (see average menu). In this mode sweeps tend to be fast but noisy. *See also System Bandwidth.*

X **X**: softkey in broadband external menu (see measurement menu). Selects diode detection type of measurement with the external detector at EXT DET X-INPUT. *See also Detection Options.*

Xon/Xoff: softkey in select copy port menu (see **HARDCOPY**). A software handshake for some serial devices. Toggles with **DTR/DSR** (see entry).

X/Y: softkey in broadband external menu (see measurement menu). Selects measurement of the ratio of the external detectors at inputs X and Y. *See also Detection Options.*

Y **Y**: softkey in broadband external menu (see measurement menu). Selects diode detection type of measurement with the external detector at EXT DET Y-INPUT. *See also Detection Options.*

Y-axis Lbl ON off: softkey in more display menu (see **DISPLAY**). Toggles on and off annotations to left of graticule: reference line indicator, graticule values, etc. Default is on. Note: graticule values are limited to four characters including "." and "-". If any graticule value exceeds four characters, all values are blanked. For example, 23.45 blanks the values; it is not rounded down as 23.4 or rounded up as 23.5. Similarly -1.23 blanks the graticule values.

Y-axis Lbl rel ABS: softkey in more display menu (see **DISPLAY**). Toggles graticule value annotation and values: in ABS mode, absolute value of each horizontal graticule line is indicated; in REL mode, value of each horizontal graticule is indicated relative to the value of the reference line.

Yes: softkey in delete limit menu (see **DISPLAY**) and format disk menu. 1. Deletes the highlighted limit line in the limit-line table. 2. Formats the disk selected: internal memory, internal disk, or external disk.

Y/R*: softkey in broadband external menu (see measurement menu). Selects measurement of the ratio of the external detectors at inputs Y and R*. *See also Detection Options.*

Y/X: softkey in broadband external menu (see measurement menu). Selects measurement of the ratio of the external detectors at inputs Y and X. *See also Detection Options.*

Z

YYYY-MM-DD HH:MM: softkey in clock format menu. Formats the real-time internal clock to display time as Year-Month-Day Hour:Minute. *See also* **Clock Format**.

Z

Preset State

Preset State

When the network analyzer is preset with the **PRESET** hardkey or HP-IB mnemonic (*RST), it sets itself to the predefined conditions listed below.

| Parameter | Setting |
|-------------------------------|--|
| BEGIN KEY SETTINGS | |
| None | |
| MEASURE KEY SETTINGS | |
| Chan 1 | Transmission, on |
| Chan 2 | Transmission, off |
| SOURCE KEY SETTINGS | |
| Start frequency | 0.3 MHz |
| Stop frequency | 1300 MHz |
| Frequency resolution | kHz |
| Power level | 0 dBm |
| RF power | On |
| Trigger | Continuous |
| Trigger source | Internal |
| Sweep time | Auto |
| Alternate sweep | Off |
| Number of points | 201 |
| External reference | Off |
| Spur avoid | Off |
| Dither | Off |
| CONFIGURE KEY SETTINGS | |
| Calibration | Last active cal if valid; otherwise, default cal |
| Detector zero | Autozero |
| Markers | Off |
| Delta marker | Off |
| Search | Off |
| Bandwidth | -3 dB |
| Tracking | Off |
| Target value | -3 dB |
| Format | Log mag |
| Average | Off |
| Average factor | 16 |
| System bandwidth | Medium |
| Scale/div | 10 |

| | |
|--------------------|----------|
| Reference level | 0 dB |
| Reference position | 5 |
| Display | Data |
| Split display | Full |
| Limit line | Off |
| Limit test | Off |
| Title+Clock | Off |
| Y-axis label | On |
| Y-axis label | Absolute |

SYSTEM KEY SETTINGS

| | |
|-------------|---------------------|
| Select disk | Internal memory |
| Define save | Instrument state on |
| | Cal off |
| | Data off |

Peripheral State

When you preset the network analyzer with the **PRESET** hardkey or HP-IB mnemonic, or cycle power, the settings below are saved in non-volatile memory and thus are not affected. The factory settings remain as shown until changed.

| Parameter | Factory Setting |
|----------------------------|----------------------|
| SYSTEM KEY SETTINGS | |
| Select disk | Internal memory |
| | Date off |
| External disk address | 0 |
| External disk volume | 0 |
| External disk unit | 0 |
| Hardcopy device | HP printer |
| Printer language | PCL |
| Hardcopy port | Parallel |
| Hardcopy address | 5 |
| Baud rate | 19200 baud |
| Handshake | Xon/Xoff |
| Define printer | Monochrome |
| | Portrait |
| | Autofeed on |
| | Top margin = 0 mm |
| | Left margin = 0 mm |
| | Print width = 150 mm |
| Define plotter | Monochrome |
| | Autofeed on |
| | Monochrome pen=1 |
| | Trace 1 = 1 |
| | Trace 2 = 2 |
| | Memory 1 = 3 |
| | Memory 2 = 4 |
| | Graticule = 5 |
| | Graphics = 6 |
| Define hardcopy | Graph and mkr table |

Define graph

Trace data on
Graticule on
Annotation on
Marker symbol on
Title+Clk on

Hardcopy address

5

HP8711 address

16

HP-IB status

Talker/listener

Clock format

YY-MM-DD HH:MM

Numeric

Seconds on

External CRT adjustments

Keyboard Front Panel Key Equivalents

You can use the key combinations below with a DIN keyboard to activate the indicated front panel hardkeys and softkeys. Softkeys are the eight unlabeled keys to the right of the display. They are numbered from one (top) through eight (bottom).

Keyboard Front Panel Key Equivalents

| Keyboard Function Key | Front Panel Equivalents | | |
|--------------------------|-------------------------|----------------|-----------|
| | Shift | Ctrl | |
| f1 | CHAN 1 | SAVE RECALL | Softkey 1 |
| f2 | CHAN 2 | HARD COPY | Softkey 2 |
| f3 | FREQ | SYSTEM OPTIONS | Softkey 3 |
| f4 | POWER | PRESET | Softkey 4 |
| | | | |
| f5 | SWEEP | BEGIN | Softkey 5 |
| f6 | MENU | | Softkey 6 |
| f7 | SCALE | | Softkey 7 |
| f8 | MARKER | | Softkey 8 |
| | | | |
| f9 | DISPLAY | | |
| f10 | FORMAT | | |
| f11 | CAL | | |
| f12 | AVG | | |

For example, to select channel 1 as the active channel, on the keyboard press **Shift** with **f1**. To preset the network analyzer with the keyboard, press **Ctrl** with **f4**. In each case hold down the first key as you press the second key. To select **Softkey 1**, press **f1** alone. In case of difficulty, make sure that the keyboard is connected to the DIN KEYBOARD connector on the rear panel. The keyboard must be IBM PC/AT compatible.

Internal Non-Volatile Memory Usage

The fastest way to save information with the HP 8711A network analyzer is to save it to internal non-volatile memory. You can access 46 Kbytes of this memory. To help you effectively use the memory available, this appendix explains:

- The type of information that can be saved and when to do so
- How much memory is used
- What to do if you run out of memory
- Examples of different saves

Three Types of Savable Information

The network analyzer can save four types of information defined by **Define Save** in **SAVE RECALL**.

- *Inst State* (instrument state): data sufficient to set up the network analyzer. The amount of memory used is independent of the number of data (frequency) points. However, when memory trace functions are used, the amount of memory required increases. Memory trace functions are **Data/Mem** and **Data and Memory**. You should save instrument states when you want to return to the same instrument setup.
- *Cal* (calibration data): error correction arrays. The amount of memory used increases with the number of data points. Reflection cals are larger than transmission cals. The instrument state is automatically saved with cal data. You should save calibrations to avoid having to perform the calibration over.
- *Data*: measurement or trace data. The amount of memory used increases with the number of data points. When data is put into memory (by pressing **Data->Mem**) it becomes a memory trace.
- *Save ASCII*: saves trace data in ASCII format for output to spreadsheets.

How to Determine the Amount of Memory Used

The following table shows how much memory is used to save instrument states, calibrations, and data. To determine how much memory is used for various combinations, just add the appropriate numbers. For example, as shown in row one, a 51 data point instrument state without memory trace and with a user defined reflection calibration is 4.9 Kbytes (3.8 plus 1.1). The same example with memory trace is 5.2 Kbytes (4.1 plus 1.1).

Approximate Non-Volatile Memory Usage (in Kbytes)

| Data Points | Instrument State | | Cal | | | | Data |
|-------------|----------------------|-------------------|----------------------|--------------|----------------------|--------------|------|
| | Without Memory Trace | With Memory Trace | Transmission | | Reflection | | |
| | | | Full Band or Default | User Defined | Full Band or Default | User Defined | |
| 51 | 3.8 | 4.1 | 4.8 | 0.6 | 14.4 | 1.1 | 0.5 |
| 101 | 3.8 | 4.4 | 4.8 | 0.9 | 14.4 | 2.0 | 0.8 |
| 201 | 3.8 | 5.0 | 4.8 | 1.5 | 14.4 | 3.8 | 1.4 |
| 401 | 3.8 | 6.2 | 4.8 | 2.7 | 14.4 | 7.5 | 2.6 |
| 801 | 3.8 | 8.6 | 4.8 | 5.1 | 14.4 | 14.7 | 5.0 |
| 1601 | 3.8 | 13.4 | 4.8 | 9.9 | 14.4 | 29.0 | 9.8 |

Notes for above table:

- Numbers are approximate.
- Saving a calibration forces an instrument state save, but the cal numbers do not include instrument state memory usage.
- All numbers except "Instrument State without Memory Trace" apply to single measurement channel; double them for dual channel measurements.
- "Instrument State without Memory Trace" numbers apply to one or two measurement channels.
- Use "Instrument State with Memory Trace" numbers when displaying memory, data/mem, or data and memory.
- Disk management overhead can add up to 0.5 Kbytes.

The following table indicates the amount of memory used to save data in an ASCII file.

| Data Points | Display Format | | |
|-------------|------------------------|-----------------|------------|
| | Typical Log Mag or SWR | Typical Lin Mag | Worst Case |
| 51 | 1.1 | 1.0 to 1.2 | 1.3 |
| 101 | 2.1 | 2.0 to 2.3 | 2.5 |
| 201 | 4.2 | 4.0 to 4.6 | 4.9 |
| 401 | 8.4 | 7.6 to 9.2 | 9.7 |
| 801 | 16.9 | 15.2 to 16.3 | 19.3 |
| 1601 | 33.6 | 31.9 to 36.8 | 38.5 |

What To Do If You Run Out of Memory

If you try to save to memory more information than can fit, the network analyzer displays this message: "Insufficient disk space." (The network analyzer categorizes internal memory as a RAM disk). To continue, either move a current file to one of the disk drives or delete one of the current files.

How to Move or Delete a File from Memory

To "move" a file, first copy it and then delete it. To copy a file, press **SAVE RECALL** and highlight the file. Make sure you are viewing the memory directory. Press **File Utilities Copy File Copy to Int Disk** or **Copy to Ext Disk**. If you want to rename the file, do so and then press **Enter**. Do not erase the first four characters of the displayed filename, "Int:" or the network analyzer won't copy to the internal disk.

To delete a file, press **SAVE RECALL File Utilities** and highlight the file. Press **Delete File**. If this does not free sufficient space, move and delete or just delete other files as required.

| | | | |
|---------------------|-------|---------------|---------------|
| DOS volume 8711_MEM | | Date and Time | Page 1/1 |
| MEM:\ | | Bytes Free: | |
| FILENAME | TYPE | SIZE | LAST CHANGE |
| .. <PARENT> | <DIR> | | |
| STATE0.STA | BDAT | 3840 | Date and Time |

Figure C-1. Save Recall Screen Annotations

Examples of Saves

The examples below illustrate memory usage for saving different types of information. If you like, perform the saves on your network analyzer. If you do, make sure you save the same instrument state as the examples below or your results will differ from those below. Pay close attention to whether the example uses a memory trace function. All of the following examples are a single trace transmission measurement of 201 points.

Example of Instrument State Save

Set the network analyzer for a single trace transmission measurement of 201 frequency points.

Press **SAVE RECALL** **Save State**. This save takes about 4.0 Kbytes as indicated by the table above (3840 bytes according to the screen). Note that number of available bytes is also displayed.

Press **DISPLAY** **Data->Mem Data and Memory** **SAVE RECALL** **Save State** to turn on one of the memory trace functions and save it with the instrument state. Note that this save takes about 5.0 Kbytes (5120 according to the screen). The difference between saving an instrument state without a memory trace and with one is about 1.0 Kbyte.

Press **DISPLAY** **Data** to turn off the memory trace function.

Example of Cal Save

Perform a user defined transmission calibration.

Press **SAVE RECALL** **Define Save Inst State OFF Cal ON**. See how the instrument state was forced on? Keep in mind that an instrument state is always saved with a cal (otherwise the calibration is useless).

Press **SAVE RECALL** **Save State** to save the calibration. This save takes about 5.5 Kbytes (5376 on screen) and includes the instrument state. It does not take 9.5 Kbytes (4.0 for instrument state and 5.5 for cal) because the cal numbers include the instrument state with memory trace functions off.

Press **DISPLAY** **Data->Mem Data and Memory** **SAVE RECALL** **Save State** to save the cal (with instrument state) and a memory trace. This save takes about 6.5 Kbytes (6656 on screen). The 6.5 Kbytes represents 5.5 for the cal (with instrument state) and 1.0 for the memory trace.

Press **DISPLAY** **Data** to turn off the memory trace function.

Example of Data Save

Press **SAVE RECALL** **Define Save** **Inst State OFF** **Data ON** to prepare to save measurement data only. (See how turning off the instrument state forced off the cal?)

Press **SAVE RECALL** **Save State** to save the measurement data. This save takes about 2.0 Kbytes (2304 on screen).

Memory Usage Notes

In general, memory usage increases with number of points and complexity of information saved.

Reflection calibrations use more memory than transmission cals because they use more error arrays.

When multiple types of information are saved together, the total is less than indicated above because redundant internal information is eliminated.

How the Analyzer Works

This chapter explains in depth a variety of network analyzer concepts:

- network analysis
- types of instrument operation
- noise reduction
- measurement calibration

The information is provided to supplement information in the other chapters of the manual. For specific reference information see chapters 1 and 7. For tutorial (“how-to”) information see chapters 4, 5, and 6. For HP-IB programming information see chapter 9. When in doubt, check the table of contents and index.

Network Analysis

At RF frequencies and above, it is difficult to directly measure voltage or current. It is often easier to measure RF or microwave energy. This energy can be likened to a light wave. A network analyzer can reflect, transmit, and absorb signals much as a lens does light. (The network analyzer, or device, can be just about anything with one or more appropriate connectors.) Thus amplitude ratios and phase differences are measured to determine the characteristics of the device. The measurements have many names but can be classified under the general headings of reflection and transmission.

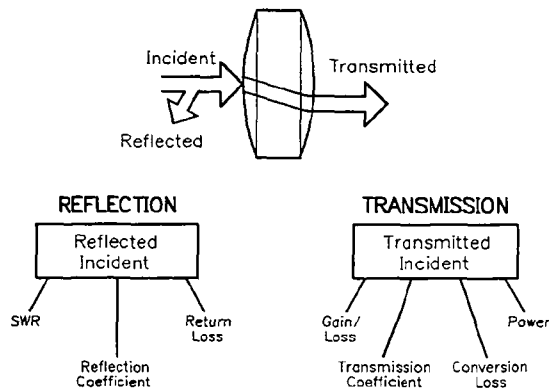

ad641a

Figure 8-1. High Frequency Device Characterization

What a Network Analyzer (NA) Measures

The ratios of (1) reflected-to-incident signals and (2) transmitted-to-incident signals may change with frequency and amplitude for a given network. Analysis refers to characterizing how a network responds to these changes.

What a NA Is

To measure these changes, an NA differs from an oscilloscope and spectrum analyzer in two important ways:

- Network analyzers incorporate an RF source.
- Network analyzers incorporate signal separation devices.

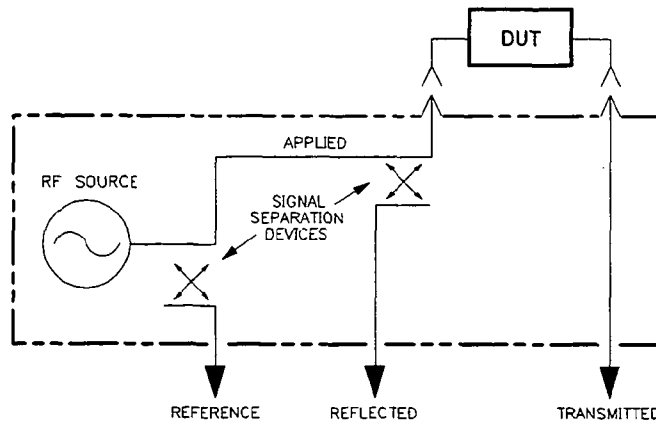

od642a

Figure 8-2. Block Diagram of Network Analyzer

The RF Source

The integral RF source enables the NA to measure non-active devices (devices that don't produce an RF signal) in addition to active devices. Since changes in frequency and amplitude response are of

interest, the RF source is designed to rapidly generate a range of frequencies.

Signal Separation

Signal separation devices (couplers or bridges) enable the NA to separate the reference, applied and reflected signals to make transmission and reflection measurements. In the HP 8711A network analyzer, a coupler divides the incident signal into reference and applied signals. For reflection measurements, the reflected signal is separated from the applied signal by a second coupler and then compared to the reference signal. For transmission measurements, the transmitted signal is compared to the reference signal.

Post Separation Processes

After the network analyzer generates and separates the signals, it detects them. Detection can be one of two modes: narrowband or broadband. Narrowband detection is a variety of tuned receiver. Broadband detection is diode detection. In each case, after detection the signal is digitized and displayed on a CRT.

Scalar vs Vector NAs

Scalar NAs, such as the HP 8711A RF network analyzer, make magnitude (but not phase) measurements. Vector NAs, make magnitude and phase measurements.

Related Topics

“Types of Instrument Operation” in this chapter.

Types of Instrument Operation

As summarized in the matrix below, the HP 8711A network analyzer can be operated remotely as well as locally, and automatically as well as manually.

| | Local | Remote |
|-----------|-------------|----------|
| Manual | Front Panel | Computer |
| Automatic | IBASIC | Program |

Manual Operation

The simplest type of operation to envision is local manual operation where the user presses the front panel keys to make measurements. Still fairly simple but not very common is remote manual operation. In this mode, the user employs a computer to send commands to the instrument. The link between the computer and the instrument is HP-IB (described below) and SCPI (Standard Commands for Programmable Instruments). SCPI is the set of commands that the network analyzer understands. These commands are also referred to as HP-IB mnemonics.

Automatic Operation

In this description, automatic operation means running the network analyzer with a computer program. Local automatic operation depends on the IBASIC option. In terms of the HP 8711A network analyzer, IBASIC describes both hardware and software: the hardware consists of the instrument's *internal* microprocessor and associated circuitry; the software (or programming language, lines of code) is a subset of HP-BASIC. IBASIC programs can be entered with an optional keyboard or from disk.

In remote automatic operation, an *external* computer with HP-IB capability controls the network analyzer with SCPI commands over HP-IB. The computer can be programmed in any number of languages including, HP BASIC, Microsoft QuickBASIC, or C.

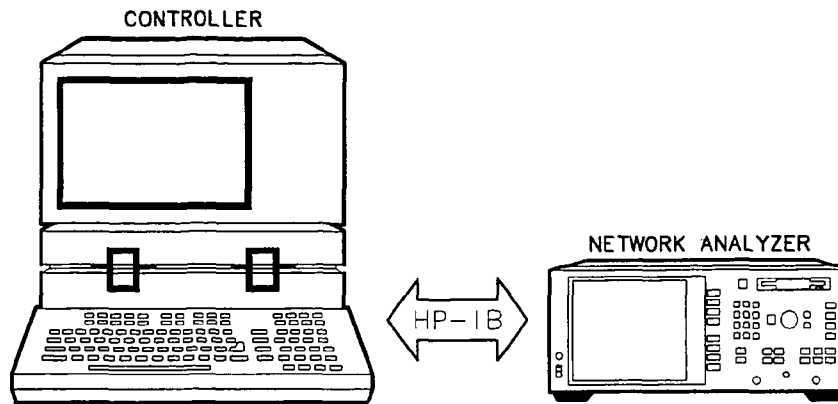

ad643a

Figure 8-3. Major Components of Remote Automatic Operation

In summary, the essence of automatic operation involves three main elements in addition to the network analyzer:

1. a program,
2. a computer (internal or external) to run the program, and
3. appropriate HP-IB connections and commands (SCPI).

HP-IB Notes

The network analyzer is factory-equipped with a remote programming interface using the Hewlett-Packard Interface Bus (HP-IB). HP-IB is HP's hardware, software, documentation, and support for IEEE-488.1 and IEC-624, world-wide standards for interfacing instruments. This provides a remote operator with the same control of the instrument available to the local operator, except for control of the power line switch and some internal tests. Several output modes are available for outputting data. A complete general description of HP-IB is available in these documents:

| HP Part Number | Item |
|----------------|--|
| 59401-90030 | Condensed Description of the Hewlett-Packard Interface Bus |
| 5952-0156 | Tutorial Description of the Hewlett-Packard Interface Bus |

Related Topics "HP-IB Programming," Chapter 9 of this manual.

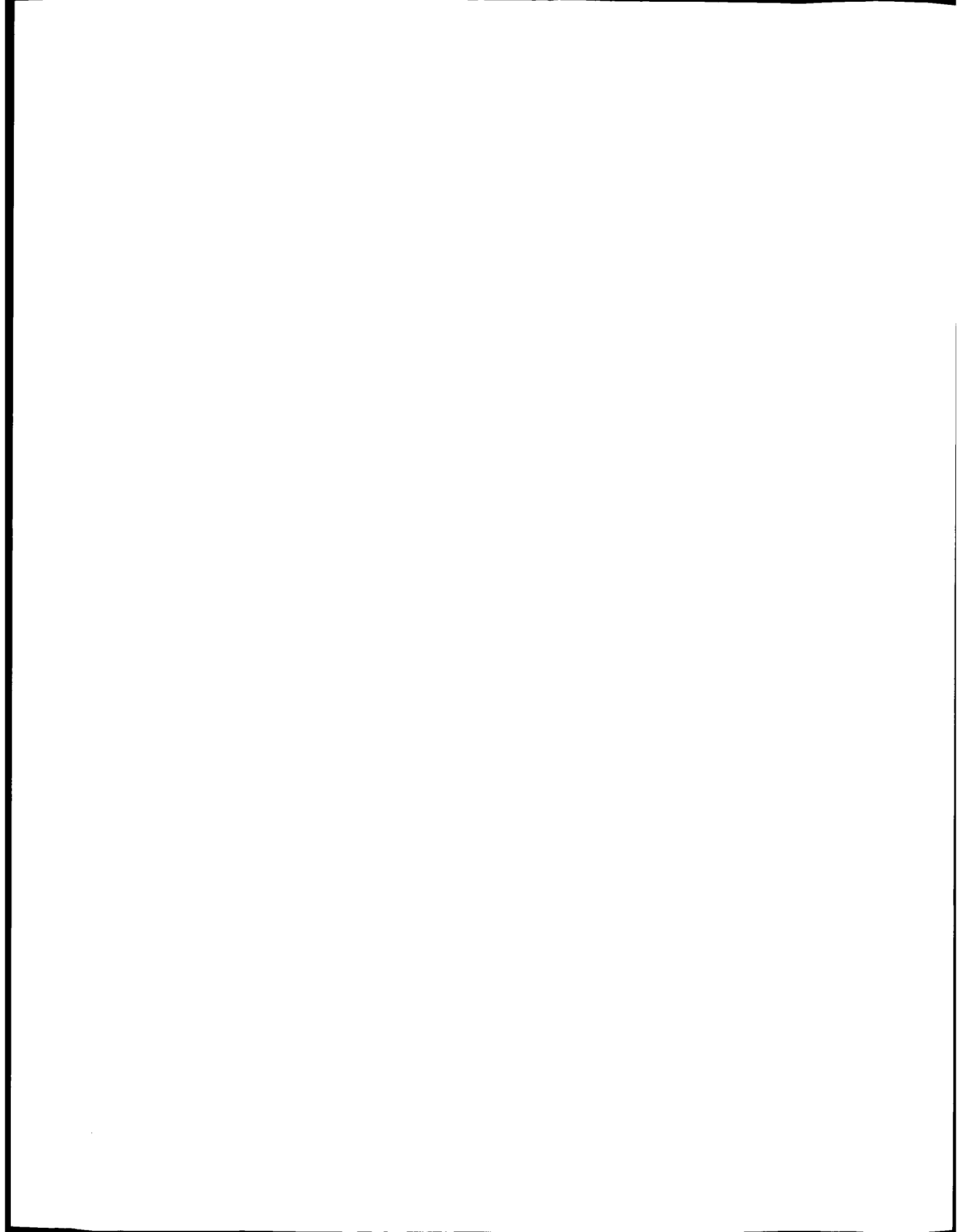

Noise Reduction

Noise reduction techniques improve measurement accuracy by increasing the signal-to-noise ratio of the DUT measurements. The two general ways to increase the signal-to-noise ratio are to (1) increase the signal level and (2) decrease the noise level. Increasing the signal level is not discussed further because it is usually straightforward. Be careful though not to overpower the receiver (damage levels are noted on the front panel) or drive it into compression. (See the specifications section in Chapter 1, "Installing the HP 8711.")

How to Decrease the Noise Level

Since noise is random, it tends to "cancel out" over time. Thus making a measurement a number of times and taking the average tends to reduce the apparent random noise. For instance, measuring a point twice (instead of just once) can decrease the noise level by up to 3 dB; measuring it four times can yield up to a 6 dB decrease, and so on, discounting the system's noise floor, etc. There are two ways to make multiple measurements.

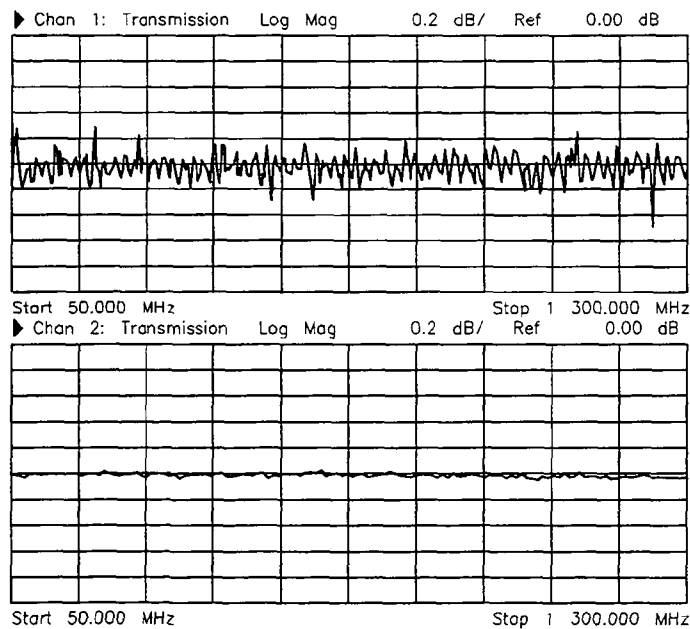

Figure 8-4. The Effect of Noise Reduction (lower) on Trace Noise

System Bandwidth Reduction

Reducing the system bandwidth lowers the noise floor by digitally reducing the receiver input bandwidth. For example, consider a three point trace of frequency points A, B, and C. The network analyzer measures the points in this order:

A₁ A₂ A₃ A₄ (combined and displayed as A_T, a single point)

B₁ B₂ B₃ B₄ (combined as B_T and displayed as A_T, B_T)

C₁ C₂ C₃ C₄ (combined as C_T and displayed as A_T, B_T, C_T)

As system bandwidth is reduced

- signal-to-noise ratio increases
- time for each individual sweep increases, but
- only one sweep is required for the desired effect.

System bandwidth tends to be faster than averaging. It is effective for filtering out spurs, harmonics, higher frequency spectral noise, and line-related noise. The HP 8711A network analyzer offers a choice of three system bandwidths: medium (default setting) wide, and narrow.

Averaging

In averaging mode, the network analyzer measures each frequency point once per sweep and averages the current and previous trace up to the averaging factor (or number) specified by the user. The instrument computes each data point based on an exponential average of consecutive sweeps weighted by a user-specified averaging factor. Repeating the example above, the network analyzer measures these points:

A₁ B₁ C₁ (first sweep, displayed as a trace)

A₂ B₂ C₂ (second sweep, combined with above trace and displayed)

A₃ B₃ C₃ (third sweep, combined with above and displayed)

A₄ B₄ C₄ (fourth sweep, combined with above and displayed)

As the averaging factor is increased:

- signal-to-noise ratio increases
- time for each individual sweep remains the same, but
- total time to update the trace increases.

Averaging is better at reducing very low frequency noise.

Related Topics

“Measurement Calibration” in this chapter.
 “Reducing Trace Noise” in Chapter 6 for examples.
 “System Bandwidth” in Chapter 7 for numbers.

Measurement Calibration

Cal Improves Measurements

Measurement calibration is a process that improves measurement accuracy by using error correction arrays to compensate for systematic measurement errors. Measurement calibration is also called cal, accuracy enhancement, and error correction. Measurement errors are classified as random, drift, and systematic errors. Random errors, such as noise and connector repeatability, are non-repeatable and not correctable by measurement calibration. Drift errors, such as frequency and temperature drift, are also non-repeatable and not correctable by a cal.

The Significance of Systematic Errors

Systematic errors, such as tracking and crosstalk, are the most significant errors in most RF measurements. Fortunately systematic errors are repeatable and for the most part correctable, though small residual errors may remain. In brief, the biggest errors are correctable.

Types of Systematic Errors

Repeatable systematic errors are due to system frequency response, isolation between the signal paths, and mismatch and leakage in the test setup.

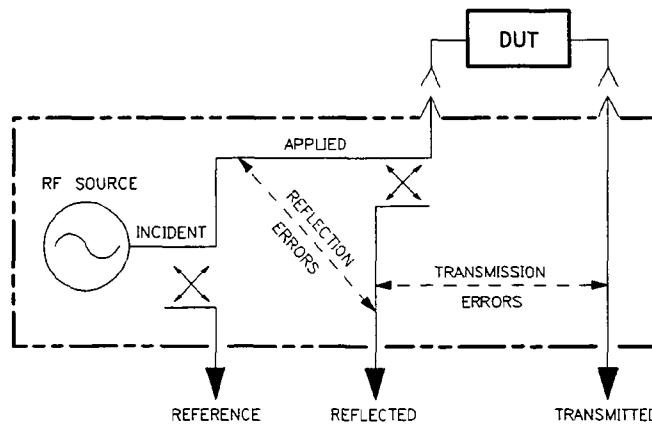

ad644a

Figure 8-5. Sources of Errors

Frequency response errors (transmission and reflection tracking) are signal changes as a function of frequency.

Isolation errors result from energy leakage between signal paths. In transmission measurements, this leakage is due to crosstalk. In reflection measurements, it is due to imperfect directivity.

Mismatch errors result from impedance mismatches at the DUT. Source match errors are produced on the source (network analyzer RF OUT) side of the DUT; load match errors on the load (network analyzer RF IN) side. If the DUT is not connected directly to the port, the mismatch errors due to cables, adapters, etc. are considered part of the source or load match errors.

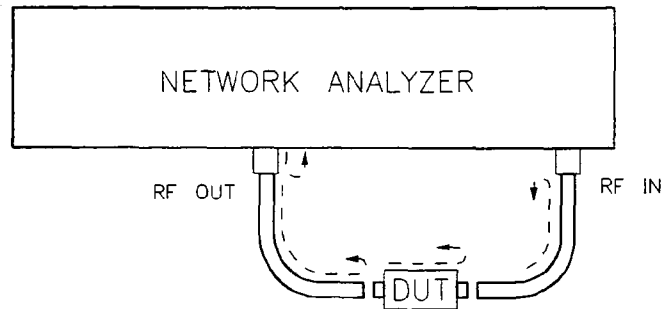

od645a

Figure 8-6. Mismatch Errors

Types of HP 8711 Cals

The HP 8711A network analyzer can use three types of cal. Two of them use data stored in error correction arrays to perform the error correction.

Normalization is the quickest, simplest type of cal. It does not use an error correction array. It simply (1) stores data into memory and (2) divides subsequent measurements by the stored data to remove frequency response errors. This is the only type of cal available for both narrowband and broadband measurements.

Transmission cals use the narrowband response error correction array to correct for frequency response tracking errors. These cals are for narrowband measurements only.

Reflection cals use the directivity, source match, and tracking error correction arrays to correct for directivity, source match and frequency response errors. These cals are also for narrowband measurements only.

Transmission and Reflection Cal Options

Transmission and reflection calibrations can be done three ways. The three ways vary in performance method, frequency span, and number of points. Data can be interpolated between points for reduced spans, but not extrapolated.

Default cals restore error correction arrays previously generated by an adjustment test and stored in memory. This cal is full band (entire frequency span) and uses 401 frequency points. It is quick and convenient but not as accurate at narrow spans as full band or user cals.

Measurement Calibration

Full Band cals use error correction arrays generated by the user at the time of calibration. Full band cals use 801 frequency points and narrow system bandwidth. They can correct for the effects of test setup attenuators, amplifiers, switches, cabling, etc. After calibration, the frequency span can be reduced. Interpolation recalculates the error correction array for reduced spans, so some accuracy is sacrificed for convenience.

User Defined cals, or user cals, also use error correction arrays generated by the user at the time of calibration. But first you must set the frequency span and then not widen it after calibration (you can narrow it). Because this cal uses the frequency span and number of points of choice (up to 1601), it is potentially the most accurate cal. It is recommended for narrow frequency spans.

How a Transmission or Reflection Cal Works

Full band and user cals correct measurement errors in three steps (default cals use just the last step):

1. The network analyzer compares the measurement data of known calibration standards to ideal measurement data. (For the default cal, this is first done at the factory.)
2. The network analyzer calculates the difference between the measurement data and the calibration standard models to create error correction arrays. (For the default cal, this is first done at the factory.)
3. The network analyzer uses the error correction array data to correct subsequent measurement data.

Typical calibration standards are cables, opens, shorts, and loads. They are used singly or in combination, depending on the type of cal. In essence, for each type of measurement error that is to be corrected, one standard is measured. For example, to simply correct for frequency response errors, one standard is measured.

An Example of a Cal

In the case of a transmission cal, the standard is an RF cable. Ideally, if the test setup (network analyzer, RF cable, any adapters or connectors) had a perfect frequency response with zero insertion loss, the transmission measurement trace would be a flat line with zero (0) dB loss. But inevitably, the setup is imperfect; the trace shows loss and frequency variations: measurement errors. Following a cal, the network analyzer compensates for these errors. After a cal, any trace variations are due to the DUT, not the test setup.

Other cals use other combinations of standards, but you can improve any of them by heeding several suggestions.

How to Perform a Quality Cal

- Use the highest quality standards available and take care of them.
- Make consistent connections (use a torque wrench if necessary) of the standards and DUTs.
- Minimize temperature variations.
- Minimize movement of cables.

Related Topics

“Noise Reduction” and “Network Analysis” in this chapter.
“Calibrating for Measurements” in Chapter 4 for examples.
“Measurement Calibration” in Chapter 7 for reference information.

Index

- 3** 3.5 mm, 7-1

- 7** 75 ohm formats, 7-2
75 ohm option, 1-6

- A**
 - A, 7-2
 - Abort, 7-2
 - Abort Cal, 7-2
 - absolute measurements, 7-2
 - accessories for the instrument, 2-6
 - activating marker functions, 5-2
 - activating spur avoidance, 6-6
 - active channel, 7-2
 - active marker, 7-2
 - adapter kits, 2-6
 - add limit, 5-19
 - Add Limit, 7-3
 - add maximum limit line, 5-19
 - Add Max Line, 7-3
 - Add Max Point, 7-3
 - Add Min Line, 7-3
 - Add Min Point, 7-3
 - All Off, 7-3
 - Alpha, 7-4
 - alternate sweep, 5-25, 6-3, 7-4
 - Alt Sweep, 7-4
 - Amplifier, 7-4
 - amplifier measurement, 4-16
 - annotation, 7-4
 - A/R, 7-4
 - autofeed, 7-4
 - Autoscale, 7-4
 - Autozero, 7-4
 - available graph components, 5-17
 - Average Factor, 7-5
 - average menu, 7-5
 - Average on OFF, 7-5
 - averaging changing, 6-5
 - averaging, how it works, 8-7
 - AVG, 7-5

- B**
 - B, 7-5
 - B*, 7-5
 - backspace, 7-2
 - Backspace, 7-5
 - bandwidth, 7-6
 - Bandwidth, 7-6
 - bandwidth change, 6-5
 - bandwidth changing, 6-4
 - bandwidth default, 6-8
 - baud rate, 5-13
 - Baud Rate, 7-6
 - Beeper Volume, 7-6
 - BEGIN**, 7-6
 - Begin Frequency, 7-7
 - BEGIN** key
 - measurement configurations, 4-1
 - network analyzer internal configurations, 4-2
 - Begin Limit, 7-7
 - B/R, 7-7
 - B*/R*, 7-7
 - broadband, 7-8
 - broadband detection, 8-3
 - broadband detection mode, 4-3
 - Broadband External, 7-8
 - Broadband Internal, 7-8
 - Broadband Passive, 7-8

- C**
 - C, 7-8
 - C?, 7-8
 - cables for printer or plotter, 5-11
 - cables, test port, 2-6
 - CAL**, 7-8
 - calculating correction constants message, 2-4
 - calibrate
 - user-defined cal kit, 6-13
 - calibration
 - conditions when it is not necessary, 6-7
 - conditions where it is necessary, 6-8
 - connections for a reflection measurement calibration, 6-11
 - determining necessity, 6-7
 - explained, 6-8
 - methods available, 6-8
 - parameters affected, 6-8
 - renaming file of saved calibration, 6-15
 - saving, 6-14
 - calibration for power measurements, 6-12
 - calibration for reflection measurements, 6-11
 - calibration menu, 7-8
 - calibration procedure
 - transmission measurement, 6-9

- calibration saving, 5-6
- cal kit
 - editing files, 6-14
 - user defined, 6-13
- Cal Kit, 7-8
- cal kits, 2-6
- cal kit standards
 - downloading, 6-13
- Cancel, 7-9
- caution
 - formatting disks, 5-9
 - receiver damage from input power, 6-12
 - receiver input damage level, 6-4
 - source compression, 4-18
- Center, 7-9
- CHAN 1, 7-10
- CHAN 2, 7-10
- change directories, 5-8
- Change Directory, 7-10
- changing directories, 5-8
- channel, 7-10
- Chan Off, 7-9
- character entry menu, 7-10
- Char Entry, 7-10
- Clear Entry, 7-10
- Clear Program, 7-10
- Clock Format, 7-10
- Clock Off, 7-11
- Color, 7-11
- commands sent for printing or plotting, 5-12
- components of graph available, 5-17
- compression of source, 4-18
- conditions where a calibration is necessary, 6-8
- conditions where a calibration is not necessary, 6-7
- CONFIGURE, 7-11
- Configure Ext Disk, 7-11
- configure hardcopy output, 5-15
- configure the network analyzer hardcopy port, 5-11
- configuring measurements from the **BEGIN** key, 4-1
- connecting your printer or plotter, 5-11
- connections
 - for a power or conversion loss measurement calibration, 6-12
- connections for a reflection measurement calibration, 6-11
- connections for a transmission measurement calibration, 6-10
- contents
 - examining measurements, 5-1
 - making measurements, 4-1
 - optimizing measurements, 6-1
- Continue, 7-11
- Continuous, 7-11
- Conversion Loss, 7-11

conversion loss and power measurements, 4-4
conversion loss measurement, 4-19
conversion loss measurement improvements, 4-19
Copy All Files, 7-11
Copy File, 7-11
Copy to Ext Disk, 7-12
Copy to Int Disk, 7-12
Copy to Int Memory, 7-12
correction constants, 7-12
create a limit test, 5-19
CW, 7-12

D damage of receiver input, 4-16
Data, 7-12
data?, 7-12
Data and Memory, 7-12
data and memory displayed, 5-23
Data/Mem, 7-12
Data->Mem, 7-12
DD-MM-YYYY HH:MM, 7-13
deadlock, 7-55
Default Pen Colors, 7-13
defaults
 instrument state, 6-8
 printer width and resolution, 5-13
defaults restored for hardcopy device, 5-14
Default Type-N(f), 7-13
define graph, 5-16
Define Graph, 7-13
Define Hardcopy, 7-13
Define Plotter, 7-13
Define Printer, 7-13
Define Save, 7-13
defining a plotting device, 5-14
defining a printing device, 5-13
defining maximum limit lines, 5-19
defining minimum limit lines, 5-20
defining what you save, 5-6
definition of plotting device, 5-14
Delete All Files, 7-13
Delete All Limits, 7-13
Delete Char, 7-13
Delete File, 7-14
Delete Limit, 7-14
delta markers, 5-5
Delta Mkr on OFF, 7-14
description of instrument, 1-2

- DeskJet print resolution, 5-14
- detection modes, 4-3
- Detection Options**, 7-14
- detection, the two types, 8-3
- Detector Zero**, 7-14
- determine if a measurement calibration is necessary, 6-7
- determine if measurement is out-of-limits, 5-22
- device configuration
 - HP-IB hardcopy, 5-12
 - RS-232 hardcopy, 5-12
- device under test (DUT) response, 4-3
- DIN KEYBOARD, 7-14
- directivity, 1-2
- directory change, 5-8
- Directory Utilities**, 7-14
- disk
 - formatting, 5-9
- disk drive, 1-2, 7-15
- disk or memory recall, 5-7
- disks
 - LIF formatted, 5-8
 - LIF formatting, 5-10
 - MS-DOS formatting, 5-9
- disks available for saving , 5-5
- disk selecting, 5-6
- Disp Freq Resolution**, 7-15
- DISPLAY**, 7-15
- display different characteristics, 5-24
- displayed measurement titled, 5-17
- display full and split screen display, 5-25
- displaying measurement traces, 5-23
- display measurements at different power levels, 5-23
- display ratio of two measurements, 5-26
- dithering, 6-6
- Dither on OFF**, 7-16
- documentation, how organized, 1-7
- DOS formatted disks, 5-9
- downloading cal kit standards, 6-13
- DTR/DSR**, 7-16
- dynamic range
 - change measurement averaging, 6-5
 - changing system bandwidth, 6-4
 - factors, 6-4
 - increase receiver input power, 6-4
 - increasing, 6-4
 - reduce receiver floor, 6-4
- dynamic range , 1-2

E

- Edit**, 7-16
- Edit Limit**, 7-16
- edit limit lines, 5-22
- eliminate receiver spurious responses, 6-6
- End Frequency**, 7-16
- End Limit**, 7-16
- End Line #**, 7-16
- Enter**, 7-16
- Enter Line 1**, 7-16
- Enter Line 2**, 7-16
- ENTRY**, 7-16
- environmental operating conditions, 2-1
- Epson compatible devices, 5-12
- Epson print resolution, 5-14
- equipment setup
 - for conversion loss measurement, 4-19
 - for power measurement, 4-16
 - for reflection measurement, 4-12
 - for transmission measurement, 4-6
- error correction arrays, 7-16
- error messages, 7-17
- examining measurements, 5-1
- example measurements
 - conversion loss, 4-19
 - power, 4-16
 - reflection, 4-10
 - transmission, 4-5
- examples
 - full and split screen display, 5-25
 - limit test, 5-19
- EXT DET X-INPUT**, 7-17
- EXT DET Y-INPUT**, 7-17
- Ext Disk Address**, 7-17
- External CRT Adjust**, 7-17
- external disk, 5-6
- External Disk**, 7-17
- external disk drive
 - MS-DOS formatting, 5-9
- External Point**, 7-18
- External Sweep**, 7-18
- EXT REF IN**, 7-18
- Ext Ref OFF on**, 7-18
- EXT TRIG IN/OUT**, 7-18

- F** fail for limit line, 5-22
- fatal error, 7-55
- features of network analyzer, 1-2
- features, optional, 1-6
- features to avoid for sweep speed increase, 6-2
- file renaming, 5-7
- file save to disk, 5-18
- file saving, 5-6
- File Utilities**, 7-18
- Filter**, 7-18
- filter measurement, 4-5, 4-10
- floppy disk, 5-6
- floppy disk formatting, 5-9
- FORMAT**, 7-19
- format a floppy disk, 5-9
- Format Disk**, 7-19
- Format Ext Disk**, 7-19
- Format Int Disk**, 7-19
- Format Int Memory**, 7-19
- formatting disk caution, 5-9
- FREQ**, 7-19
- Frequency**, 7-19
- frequency change to increase sweep speed, 6-2
- frequency default, 6-8
- frequency menu, 7-20
- front panel features, 1-3
- Full**, 7-20
- full and split screen display, 5-25
- full band, 6-9
- Full Band**, 7-20

- G** gain difference between two power levels, 5-26
- generate a hardcopy output, 5-17
- Graph and Mkr Table**, 7-21
- graph components available, 5-17
- graph definition, 5-16
- Graphics**, 7-21
- Graph Only**, 7-21
- Graticule**, 7-21
- Graticule ON off**, 7-21
- graticule values not visible, 7-57

- H** hardcopy
 - output configuration , 5-15
 - HARDCOPY**, 7-21
 - Hardcopy Address**, 7-22
 - hardcopy configuration
 - HP-IB devices, 5-12
 - RS-232 devices, 5-12
 - hardcopy device
 - defaults restored, 5-14
 - hardcopy device settings, 5-13
 - hardcopy generation, 5-11, 5-17
 - hardcopy port configuration, 5-11
 - hardcopy speed, 5-12
 - hardkey, 7-1
 - HARDKEY**, 7-23
 - Hold**, 7-23
 - Horizontal Back Porch**, 7-23
 - Horizontal Frnt Porch**, 7-23
 - HP8711 Address**, 7-23
 - HP 8711A network analyzer connection to printer or plotter, 5-11
 - HPGL commands for printer or plotter, 5-12
 - HP-IB, 7-23
 - HP-IB address, 7-3
 - HP-IB addresses, how to set, 2-4
 - HP-IB device configuration for hardcopy, 5-12
 - HP-IB Echo on OFF**, 7-23
 - HP-IB** softkey, 7-23
 - Hz**, 7-24

- I** IBASIC, 7-24
 - IBASIC Display**, 7-24
 - IBASIC option, 1-6
 - IBASIC** softkey, 7-24
 - IBM commands for printer of plotter, 5-12
 - improvements
 - for conversion loss measurements, 4-19
 - for reflection measurements, 4-10
 - for transmission measurements, 4-5
 - power measurement, 4-16
 - increase receiver input power, 6-4
 - increase start frequency, 6-2
 - increasing dynamic range, 6-4
 - increasing measurement accuracy, 6-7
 - increasing sweep speed, 6-2
 - information saved, 5-5
 - initializing a disk, 5-10
 - instrument description, 1-2
 - Instrument Info**, 7-24
 - instrument, items supplied, 2-1
 - instruments covered by manual, 1-8
 - instrument setup, 2-2

- instrument specifications, 1-9
- instrument state, 7-24
- instrument state default, 6-8
- Instrument State ON off**, 7-24
- instrument state settings, 5-5
- Internal**, 7-24
- internal disk, 5-6
- Internal Disk**, 7-25
- internal disk drive
 - LIF formatting, 5-10
- internal drive
 - MS-DOS formatting, 5-9
- Internal Memory**, 7-25
- items supplied with network analyzer, 2-1

K

- keyboard, 7-25
- keyboard option, 1-6
- Key Record on OFF**, 7-25
- kHz**, 7-25

L

- Landscape**, 7-25
- LaserJet print resolution, 5-14
- Left Margin**, 7-25
- Level**, 7-25
- LIF formatted disks, 5-8
- LIF formatting, 5-10
- Limit**, 7-26
- Limit Line**, 7-26
- limit-line menu, 7-26
- Limit Line on OFF**, 7-26
- limit lines, 5-18
 - defining minimum limit lines, 5-20
- limit points, 5-18
- limit test
 - add limit, 5-19
 - create a test, 5-19
 - edit limits, 5-22
 - marker, 5-20
 - maximum limit-lines definition, 5-19
 - out-of-limits, 5-22
 - setting up, 5-19
- limit testing, 5-18
- Limit Test on OFF**, 7-26
- LIMIT TEST TTL IN/OUT, 7-26
- line editing for limits, 5-22
- lines of limits, 5-18
- line voltage selector switch, 7-26
- line voltage setting, 2-3
- listener, 7-26
- List Trace Values**, 7-27
- lock-up, how to fix, 2-4

Log Mag, 7-27

Lower, 7-27

M

/M, 7-2

Mag dBmV, 7-27

Mag dBuV, 7-27

Mag dBV, 7-27

make and change directories, 5-8

Make Directory, 7-27

manual, description of, 1-8

manual, instruments it covers, 1-8

manual, organization of, 1-7

Manual Zero, 7-27

margin default for printer, 5-13

marker, 7-27

Marker, 7-28

MARKER, 7-28

marker functions

activating, 5-2

search:maximum and minimum values, 5-2

search:specific values, 5-2

Marker Functions, 7-29

Marker → Center, 7-29

Marker → Reference, 7-29

markers

delta, 5-5

limit test, 5-20

reference, 5-5

search:bandwidth values, 5-3

search:target values, 5-3

Marker Search, 7-29

maximum limit-lines definition, 5-19

MEAS, 7-29

measurement accessories, 2-6

measurement averaging, 6-5

measurement calibration, 1-2, 7-29

conditions when it is not necessary, 6-7

conditions where it is necessary, 6-8

connections for a power or conversion loss measurement calibration, 6-12

connections for a reflection measurement calibration, 6-11

determining necessity, 6-7

explained, 6-8

methods available, 6-8

parameters affected, 6-8

renaming file of saved calibration, 6-15

saving, 6-14

measurement calibrations

for a power measurement, 6-12

measurement calibration, theory of, 8-8

measurement cals, 6-7

measurement detection modes, 4-3

- measurement menu, 7-29
- measurement procedure
 - power, 4-16
- measurement procedures
 - conversion loss, 4-19
 - reflection, 4-10
 - transmission, 4-5
- measurement result printing and plotting, 5-11
- measurements, 4-1
 - chapter, 4-1
 - conditions where a calibration is necessary, 6-8
 - conditions where a calibration is not necessary, 6-7
 - display different characteristics, 5-24
 - displaying, 5-23
 - explained, 4-3
 - from the **(BEGIN)** key, 4-1
 - increasing accuracy, 6-7
 - optimizing, 6-1
 - ratio of two data traces, 5-26
 - title, 5-17
- measurement setup
 - for power, 4-16
- measurement speed with hardcopy, 5-12
- measuring devices, 4-3
- Medium**, 7-31
- medium bandwidth, 6-4
- Memory**, 7-31
- Memory 1**, 7-31
- Memory 2**, 7-31
- memory and data displayed, 5-23
- memory or disk recall, 5-7
- Memory Size**, 7-31
- (MENU)**, 7-32
- menu map, 7-32
- messages, 7-32
- MHz**, 7-32
- mixer, 7-32
- Mixer**, 7-32
- mixer measurement, 4-19
- Mkr->Max**, 7-32
- Mkr->Min**, 7-32
- Mkr Symbol ON off**, 7-32
- Mkr Table Only**, 7-32
- MM-DD-YYYY HH:MM**, 7-33
- mnemonics, 7-1
- Monochrome**, 7-33
- Monochrome Pen**, 7-33
- More Display**, 7-33
- More Markers**, 7-33
- More Printer**, 7-33

MS-DOS formatting, 5-9
external disk drive, 5-9

- N**
 - Narrow**, 7-33
 - narrowband, 7-33
 - narrowband detection , 8-3
 - narrowband detection mode, 4-3
 - Narrowband Internal**, 7-33
 - narrow bandwidth, 6-4
 - network analysis explained, 8-1
 - network analyzer hardcopy port configuration, 5-11
 - network analyzer input channels, 4-3, 4-5
 - No**, 7-33
 - no graticule values, 7-57
 - noise
 - trace:activate averaging, 6-5
 - trace:change system bandwidth, 6-5
 - trace:eliminate receiver spurious responses, 6-6
 - trace: reduction, 6-5
 - noise floor reduction, 6-4
 - noise reduction, theory of, 8-6
 - None**, 7-33
 - non-volatile memory, 7-33
 - normalization
 - explained, 6-8
 - Normalize**, 7-34
 - Number of Points**, 7-34
 - Numeric**, 7-34
 - numeric entries, 7-1

- O**
 - ON switch, 7-34
 - operating conditions, 2-1
 - optimizing measurements, 6-1
 - optional features, 1-6
 - out-of-limits for limit test, 5-22
 - output configuration for hardcopy, 5-15
 - output hardcopy, 5-17
 - output power, 1-2
 - overall menu map, 7-34

- P**
 - PaintJet print resolution, 5-14
 - PARALLEL PORT, 7-34
 - parameters affected in calibration, 6-8
 - PCL commands for printer or plotter, 5-12
 - Perform Secure**, 7-34
 - Peripheral State, A-2
 - plotter or printer connection, 5-11
 - plotting and printing, 5-11
 - plotting device definition, 5-14
 - plot to disk, 5-18
 - points of limits, 5-18
 - points reduction, 6-3

- port configuration for hardcopy, 5-11
- Portrait**, 7-35
- Power**, 7-35
- POWER**, 7-36
- power accuracy, 4-16
- power and conversion loss measurements, 4-4
- power cord receptacle, 7-36
- power default, 6-8
- power level difference in measurements, 5-23
- power measurement
 - equipment setup, 4-16
- power measurement calibration, 6-12
- power measurement procedure, 4-16
- power-up, 7-36
- PRESET**, 7-37
- printer
 - resolutions, 5-14
- printer or plotter connection, 5-11
- Printer Resolution**, 7-36
- printing and plotting
 - baud rate, 5-13
- printing and plotting, 5-11
- printing device definition, 5-13
- print margin default, 5-13
- print width default, 5-13
- Prior Menu**, 7-36
- PROBE POWER**, 7-37
- procedure
 - activate averaging, 6-5
 - activating spur avoidance, 6-6
 - change system bandwidth, 6-5
 - changing measurement averaging, 6-5
 - changing system bandwidth, 6-4
 - dithering, 6-6
 - eliminate receiver spurious responses, 6-6
 - for a transmission measurement calibration, 6-10
 - for power measurement calibration, 6-12
 - for reflection measurement calibration, 6-11
 - increase receiver input power, 6-4
 - increase start frequency, 6-2
 - increasing dynamic range, 6-4
 - increasing sweep speed, 6-2
 - reduce amount of averaging, 6-2
 - reduce number of measurement points, 6-3
 - reduce receiver noise floor, 6-4
 - reducing trace noise, 6-5
 - renaming calibration file, 6-15
 - save the measurement calibration, 6-14
 - set sweep to preset mode, 6-2
 - spur shifting, 6-6
 - turn off alternate sweep, 6-3
 - turn off spur avoidance, 6-3
 - widen system bandwidth, 6-2
- procedures

- conversion loss measurement, 4-19
- power measurement, 4-16
- reflection measurement, 4-10
- transmission measurement, 4-5

Programs, 7-37

Q QuietJet print resolution, 5-14

R **R**, 7-37

R*, 7-37

ratio of two measurements displayed, 5-26

rear panel features, 1-5

recall from a disk or memory, 5-7

Recall Program, 7-37

Recall State, 7-37

receiver damage input level, 6-12

receiver input damage, 4-16

receiver input damage level, 6-4

receiver input power increase, 6-4

receiver inputs, 4-3

receiver noise

- dithering, 6-6

- spur avoidance, 6-6

receiver noise floor reduction, 6-4

receiver's most linear operation, 4-16

recognized HP-IB address, 7-37

reduce number of measurement points, 6-3

reduce receiver noise floor, 6-4

reduce the amount of averaging, 6-2

reducing trace noise, 6-5

Ref, 7-38

Reference Level, 7-38

reference line, 7-38

reference markers, 5-5

Reference Position, 7-38

reflection, 7-38

Reflection, 7-38

reflection and transmission calibrations available, 6-9

reflection and transmission measurements explained, 4-3

reflection calibration

- explained, 6-8

reflection cal menu, 7-38

reflection measurement

- equipment setup, 4-12

- improvements, 4-10

- procedure, 4-10

reflection measurement calibration, 6-11

REFLECTION RF OUT, 7-38

register, 7-38

relative measurements, 7-39

Remove Directory, 7-39

Rename File, 7-39
renaming a calibration file, 6-15
renaming a file, 5-7
Re-Save Program, 7-39
Re-Save State, 7-39
resolution settings for printer, 5-14
Restart Average, 7-39
restore defaults, 6-9
Restore Defaults, 7-39
restoring your hardcopy device defaults, 5-14
results of measurement titled, 5-17
RF cables, 2-6
RF ON off, 7-39
Round Seconds, 7-39
RS-232 device configuration for hardcopy, 5-12
Run, 7-40

S safety classifications, 2-1
save a plot file to disk, 5-18
Save ASCII, 7-40
Save AUTOST, 7-40
save definition, 5-6
Save Program, 7-40
SAVE RECALL, 7-41
Save State, 7-40
saving a calibration, 5-6
saving a measurement calibration, 6-14
saving and recalling measurement results, 5-5
SCALE, 7-43
Scale/Div, 7-44
schematic package, 1-6
screen symbols, 7-4
Search Left, 7-44
Search Off, 7-44
Search Right, 7-45
Seconds ON off, 7-45
Secure, 7-45
Select, 7-45
Select Char, 7-45
Select Copy Port, 7-45
Select Disk, 7-45
selecting the disk, 5-6
select your hardcopy device settings, 5-13
self-test, 7-45
send plot file to disk, 5-18
serial number, 2-2
Service, 7-45

- Service Utilities**, 7-45
- Set Clock**, 7-46
- Set Day**, 7-46
- Set Hour**, 7-46
- Set Minute**, 7-46
- Set Month**, 7-46
- Set Pen Numbers**, 7-46
- settings for hardcopy device, 5-13
- setting up the limit test, 5-19
- Set Year**, 7-46
- shift spurs, 6-6
- Show Clock on Line 1**, 7-46
- Show Clock on Line 2**, 7-46
- signal separation, 8-3
- Single**, 7-46
- softkey, 7-1
- Softkey**, 7-47
- SOURCE**, 7-47
- source compression caution, 4-18
- source menu, 7-47
- source resolution, 1-2
- Space**, 7-47
- Span**, 7-47
- specifications of instrument, 1-9
- speed increase of sweep, 6-2
- speed with hardcopy, 5-12
- Split**, 7-48
- Split Disp**, 7-48
- split screen display, 5-25
- Spur Avoid**, 7-48
- spur avoidance, 6-3, 6-6
- spur avoid menu, 7-48
- Spur Avoid on OFF**, 7-48
- standby switch, 7-34
- Start**, 7-49
- start frequency change to increase sweep speed, 6-2
- Start Line #**, 7-49
- status notation, 7-49
- Step**, 7-49
- Stop**, 7-49
- stop printer, 7-2
- storing measurement results, 5-5
- support options, 1-7
- sweep, 7-49
 - alternate, 5-25
 - SWEEP**, 7-49
 - sweep speed
 - increase start frequency, 6-2
 - increasing, 6-2

- reduce averaging, 6-2
- reduce number of points, 6-3
- turn off alternate sweep, 6-3
- turn off spur avoidance, 6-3
- use preset mode, 6-2
- view single measurement channel, 6-3
- Sweep Time**, 7-50
- Sweep Time AUTO man**, 7-50
- SWR**, 7-50
- symbolic entries, 7-1
- SYSTEM**, 7-50
- systematic errors, 8-8
- system bandwidth, 6-4
- System Bandwidth**, 7-50
- system bandwidth change, 6-5
- system bandwidth, how it works, 8-7
- System Config**, 7-50
- System Controller**, 7-51
- system crash, 7-55
- system errors, 6-8
- SYSTEM OPTIONS**, 7-51

T

- talker, 7-53
- Talker/Listener**, 7-53
- Target Search**, 7-53
- Target Value**, 7-53
- techniques
 - for conversion loss measurements, 4-19
 - for power measurements, 4-16
 - for reflection measurements, 4-10
 - for transmission measurements, 4-5
 - optimizing measurements, 6-1
- testing with limits, 5-18
- test out-of-limits, 5-22
- TEST RESULTS**, 7-53
- Tests and Adjustments**, 7-53
- ThinkJet print resolution, 5-14
- Title and Clock**, 7-53
- Title+Clk ON off**, 7-53
- title displayed measurement, 5-17
- Top Margin**, 7-53
- Trace 1**, 7-54
- Trace Data ON off**, 7-54
- trace noise
 - activate averaging, 6-5
 - change system bandwidth, 6-5
 - eliminate receiver spurious responses, 6-6
 - factors, 6-5
 - reduction, 6-5
- Tracking on OFF**, 7-54

transmission, 7-54
transmission and reflection calibrations available, 6-9
transmission and reflection measurements explained, 4-3
transmission calibration
 explained, 6-8
transmission cal menu, 7-54
transmission measurement
 equipment setup, 4-6
 improvements, 4-5
 procedure, 4-5
transmission measurement calibration, 6-10
TRANSMISSION RF IN, 7-54
Transmissn, 7-54
trigger, 7-55
Trigger, 7-55
Trigger Source, 7-55
Type-N(m), 7-55
typographical conventions, 1-8

U unrecoverable error, 7-55
Update Corr Const, 7-55
Upper, 7-55
user-defined, 6-9
User Defined, 7-56
user-defined cal kit, 6-13
USER TTL IN/OUT, 7-56
Utilities, 7-56

V Vertical Back Porch, 7-56
Vertical Frnt Porch, 7-56
vertical scale, how to set, 7-4
VIDEO OUT, 7-56
view a single measurement channel, 6-3

W Wide, 7-57
wide bandwidth, 6-4
width default for printer, 5-13

X X, 7-57
Xon/Xoff, 7-57
X/Y, 7-57

Y Y, 7-57
Y-axis Lbl ON off, 7-57
Y-axis Lbl rel ABS, 7-57
Yes, 7-57
Y/R*, 7-57
Y/X, 7-57
YYYY-MM-DD HH:MM, 7-58